



MATTHIÆ DÖGEN  
*Dramburgensis Marchici*

# ARCHITECTURA MILITARIS MODERNA.

Varijs Historijs, tam veteribus quam novis  
confirmata, et præcipuis totius Europæ mu-  
nimentis, ad exemplum adductis exornata.

AMSTELODAMI,  
Apud Ludovicum Elzevirium. Anno 1647.

DEPARTEMENT  
BIBLIOTHEEK  
VAN OORLOG.

in Folio. N<sup>o</sup> 17.  
Bibliotheek

Hogere Vorming KL/KLa





EHRNBREITSTEIN of HERMANSTEIN.



R H E N U S F L U .

MOSSEI F.S.

COBLENZ

KVSTRIN.

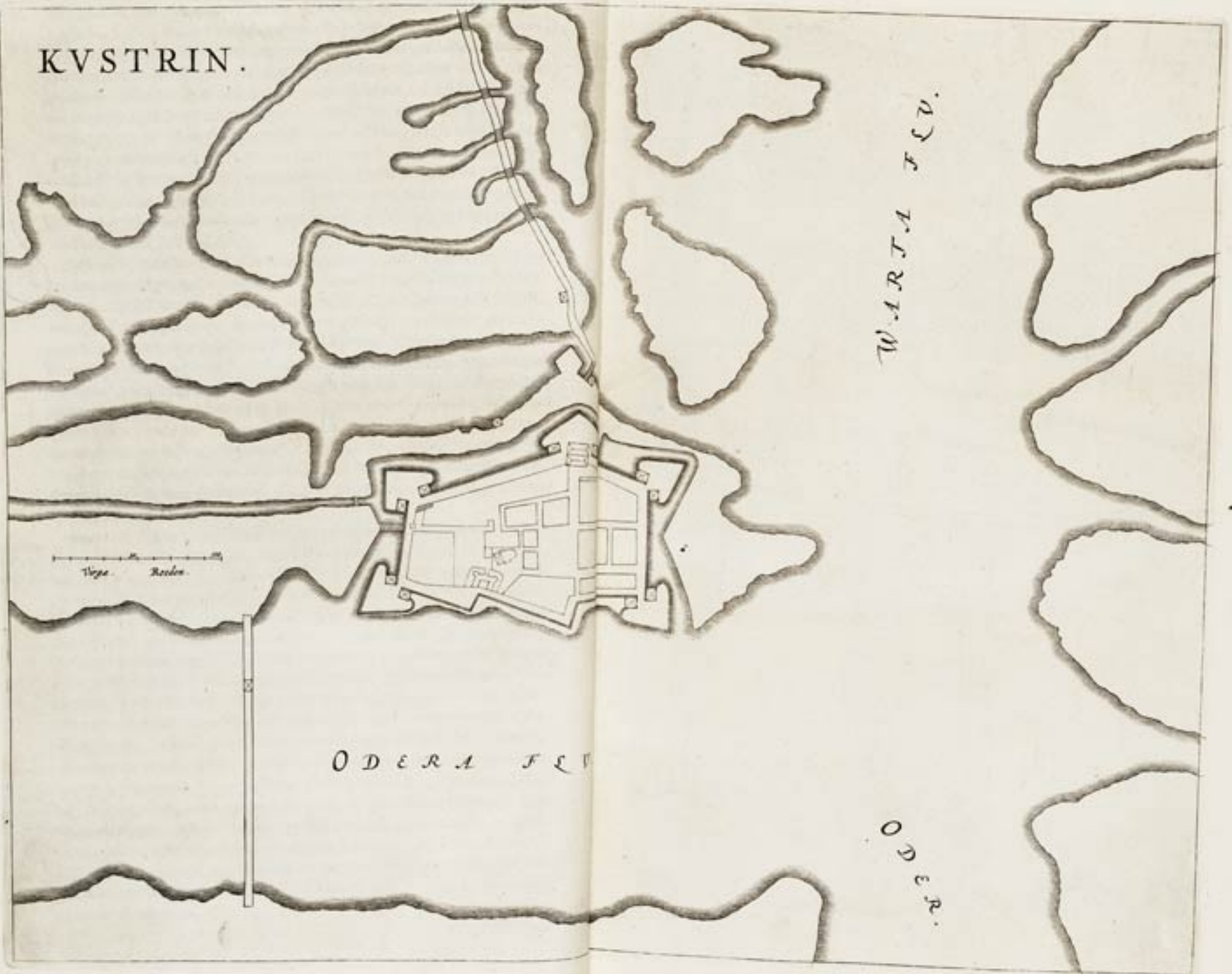

WARTA FLU.

ODERA FLU

ODERA



STRAELSVNDT

MARIS BALTHICI

*Wedroncken*

*Landen*

PARS

*Wedroncken*

*Landen*

*Viege Roeden*





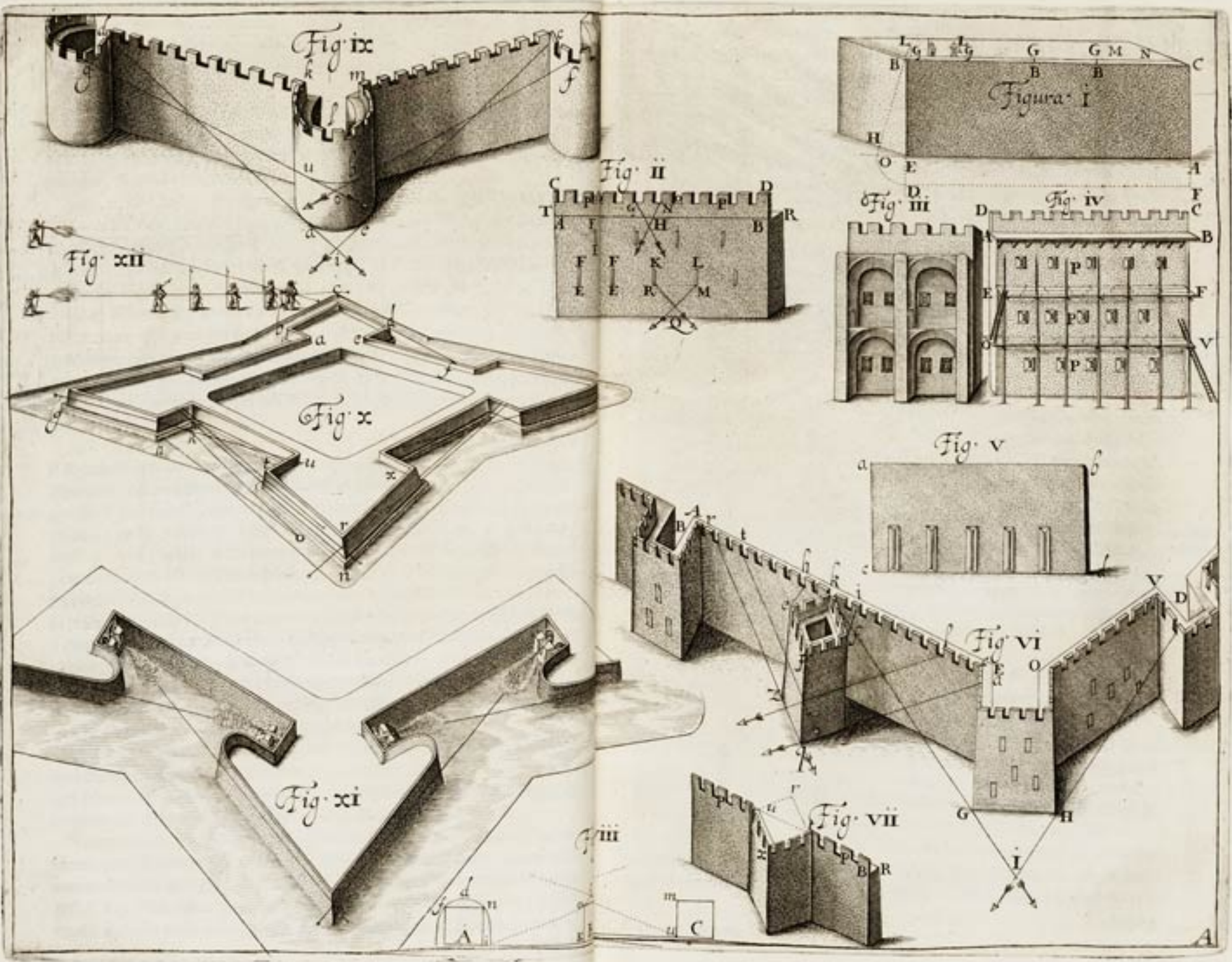



NOVA

PALMA

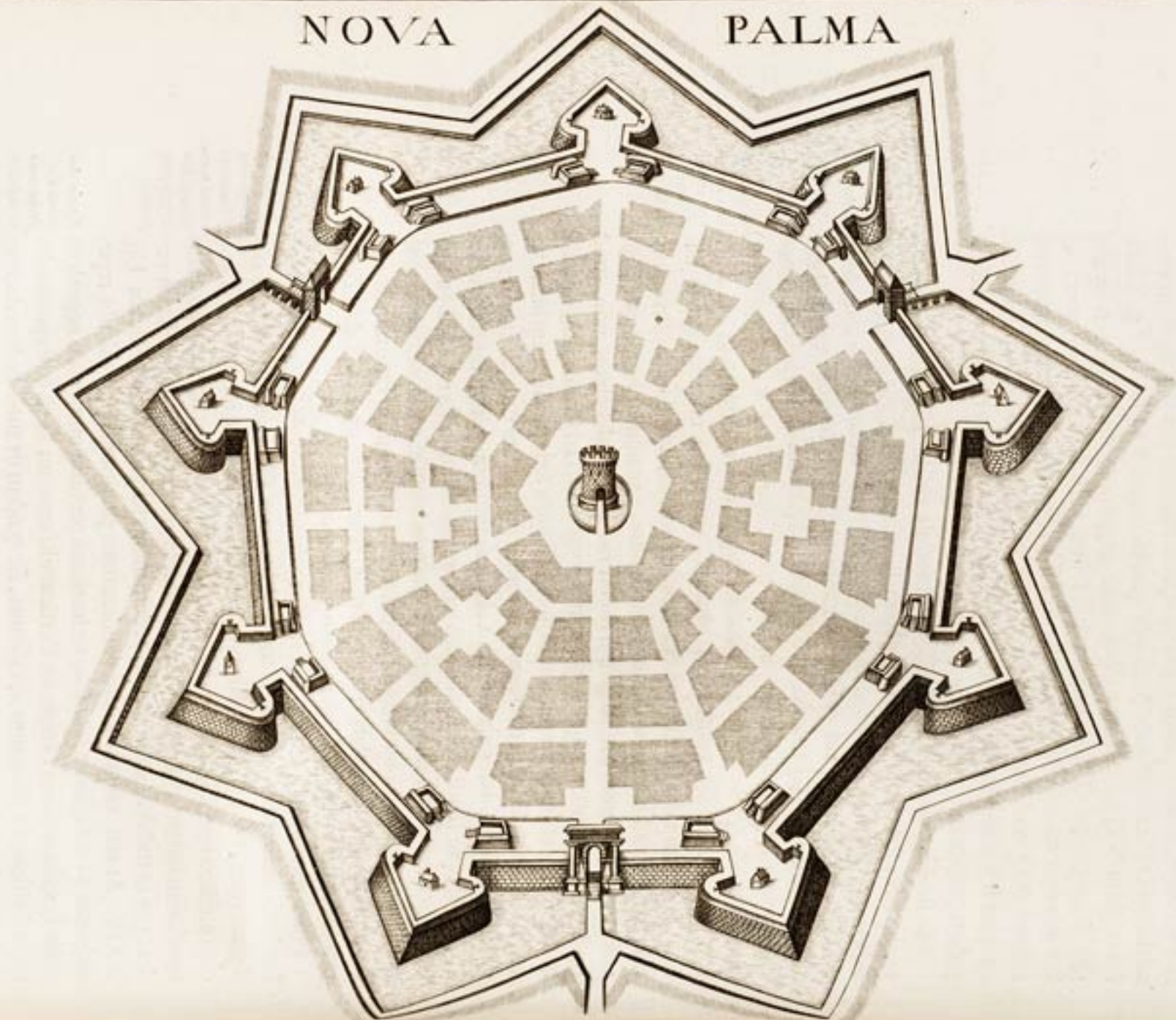



V DENHEIM  
PHILIPS-BVRG

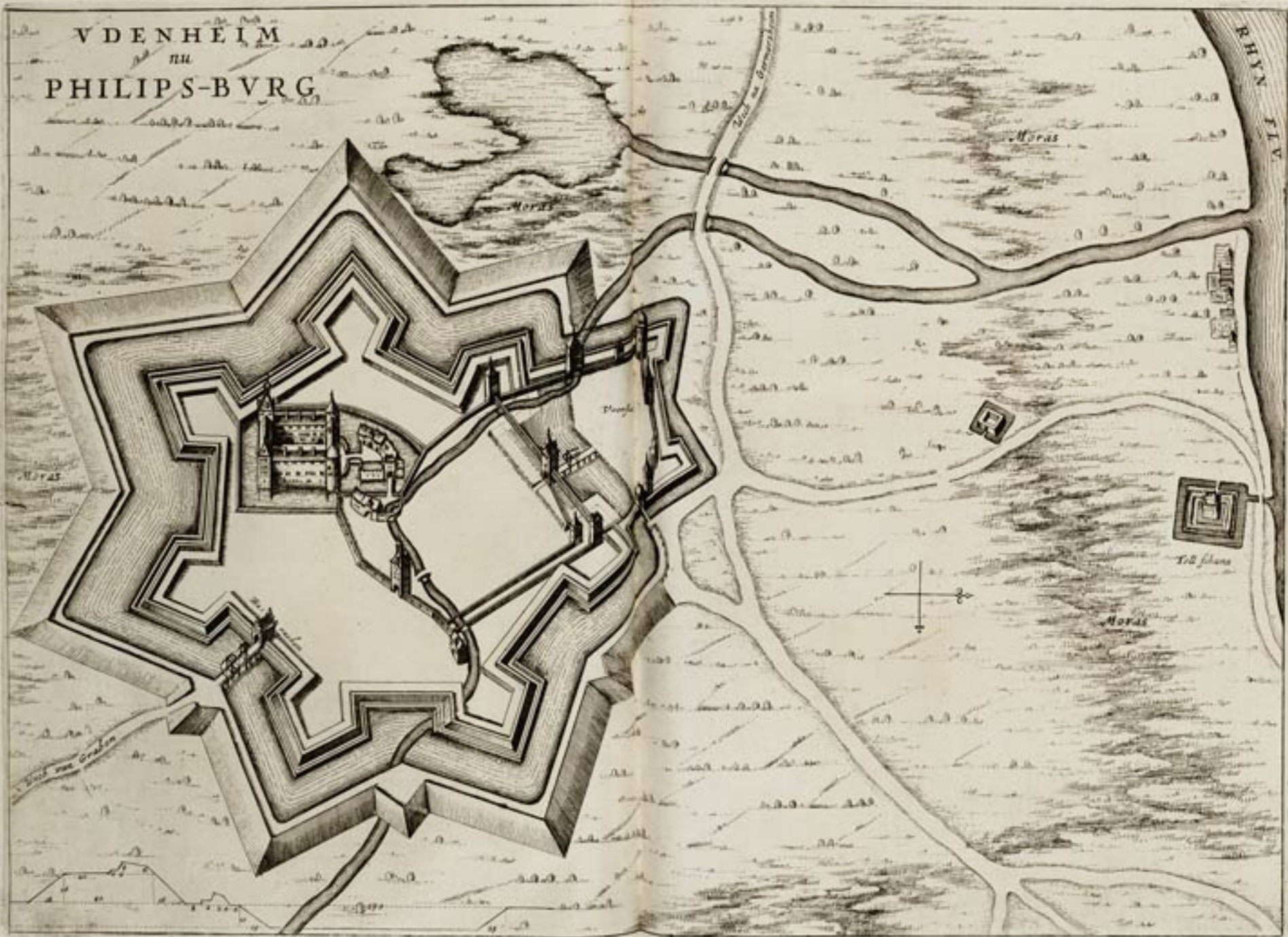



RHEES.

RHEENVS F. V.

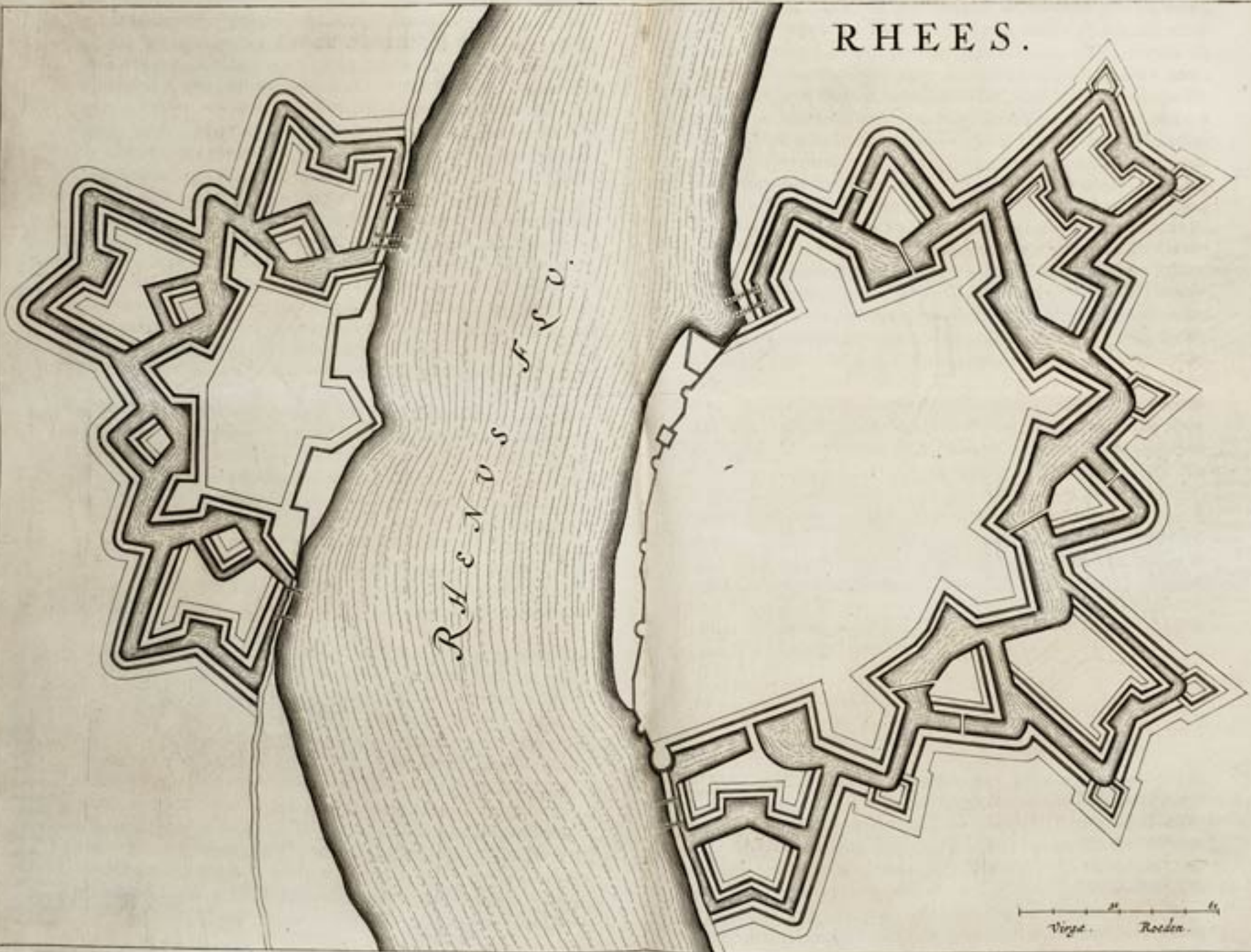



FRANCKENDAEL.

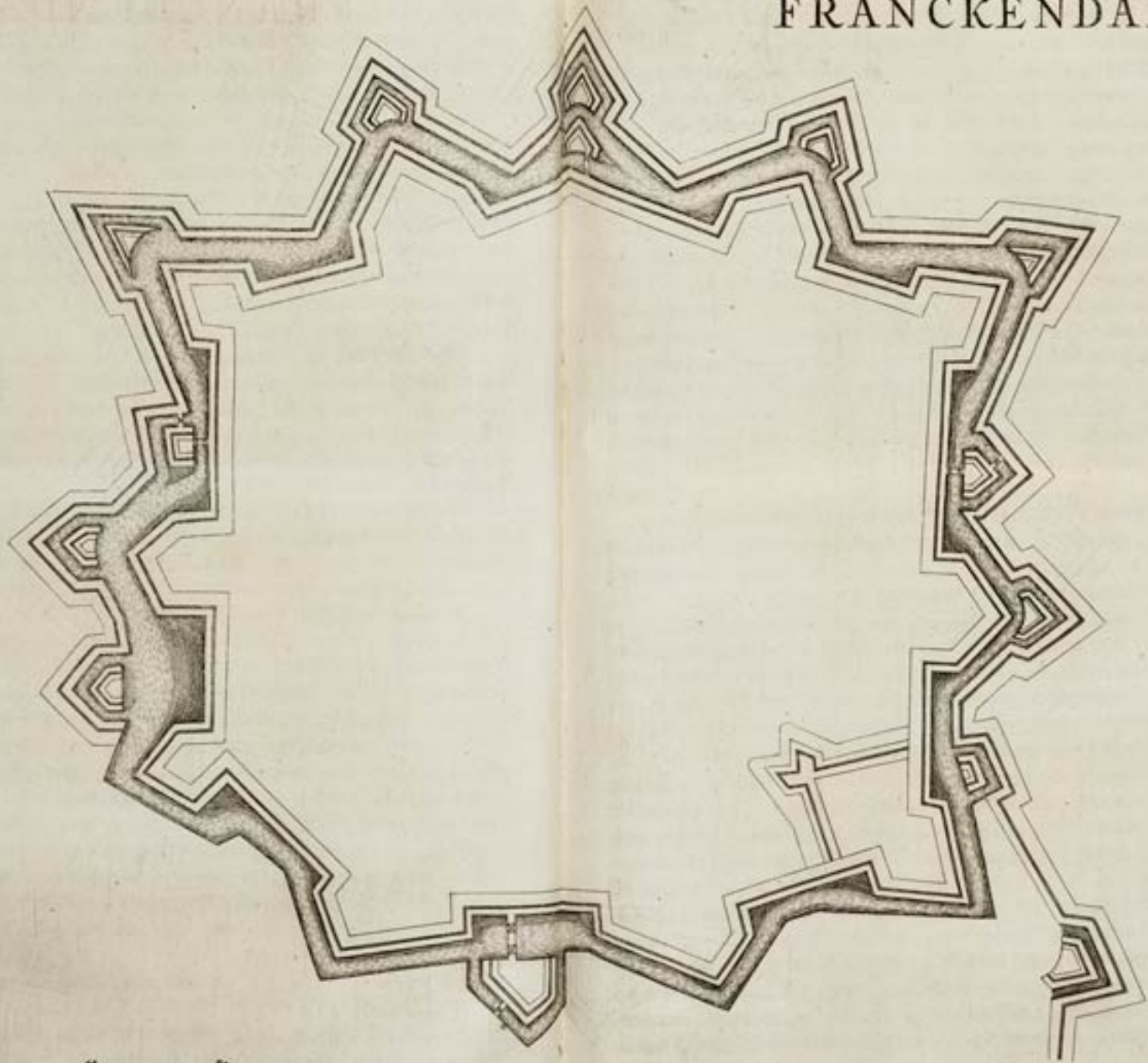

Virge.      40      80  
Roden.



# AEMSTELERDAM.

150 Rhynlandfche roeden.

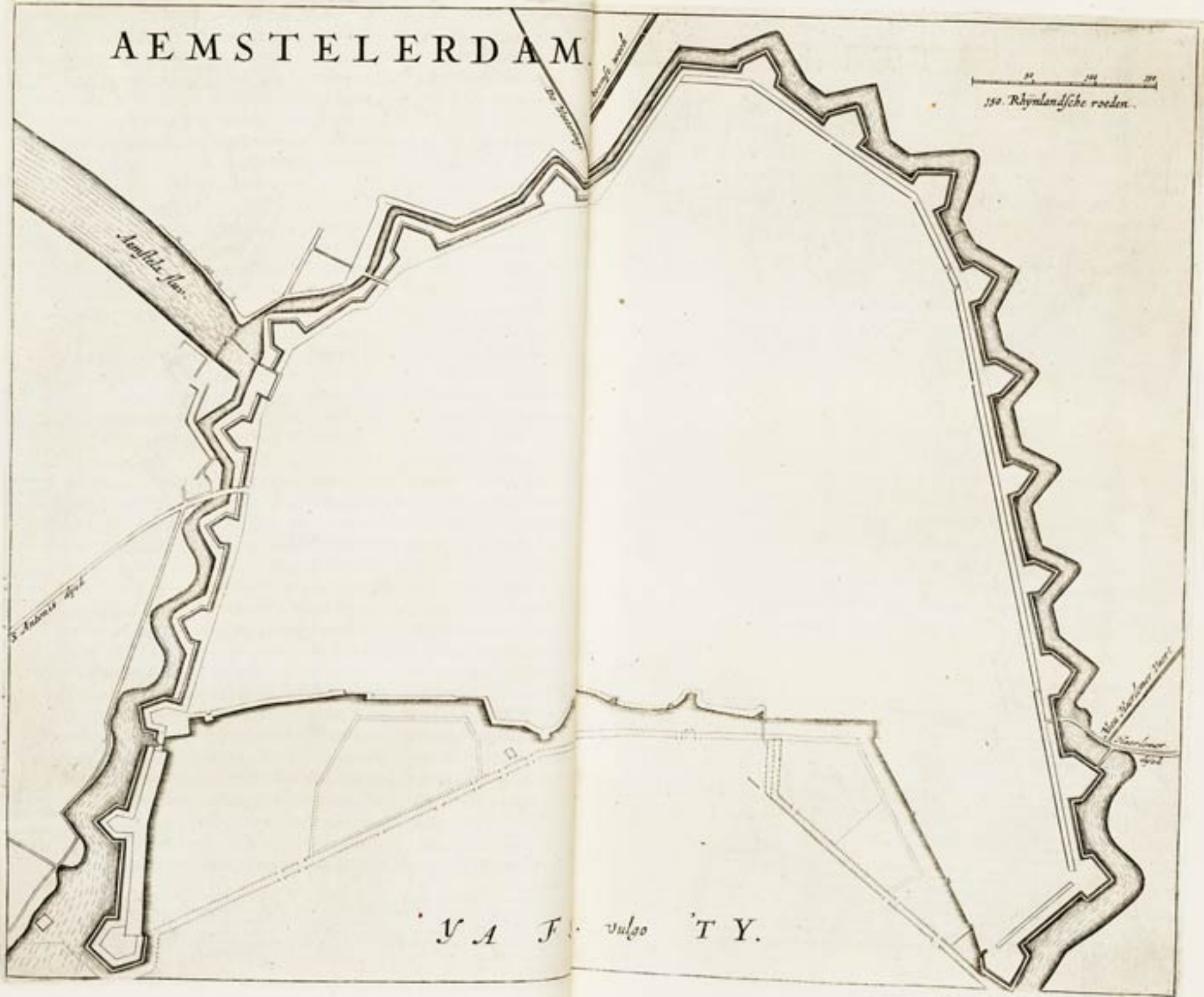

Y A F. vulgo T Y.



Figura. x

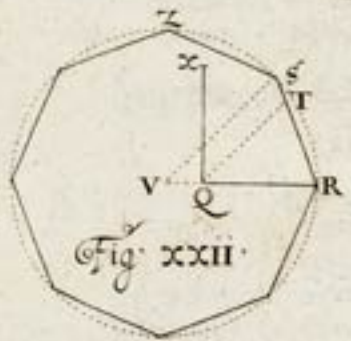
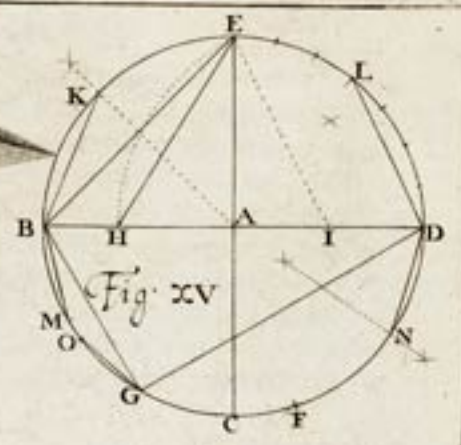
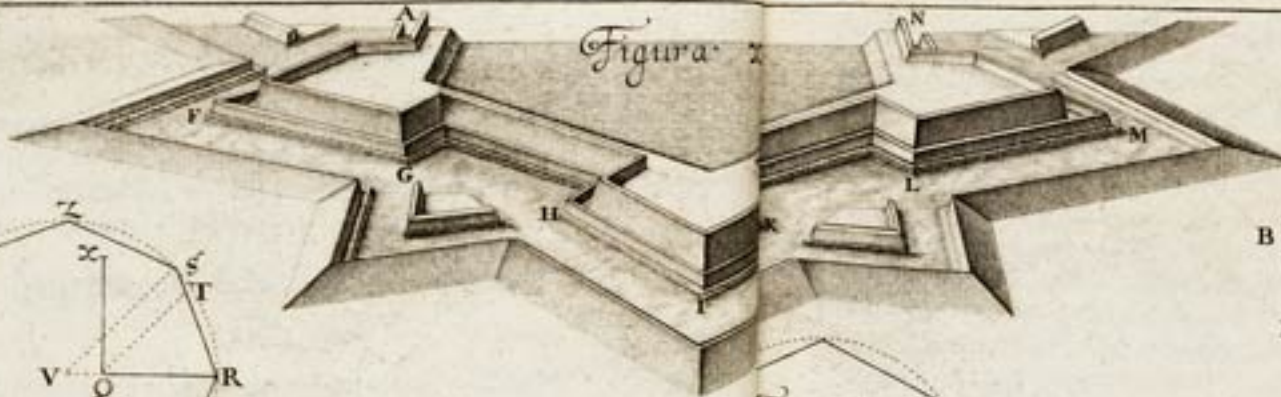

O — P

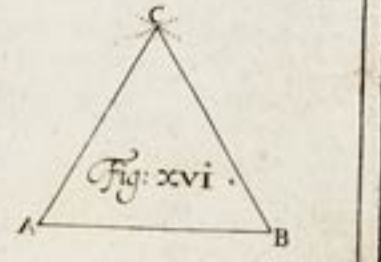
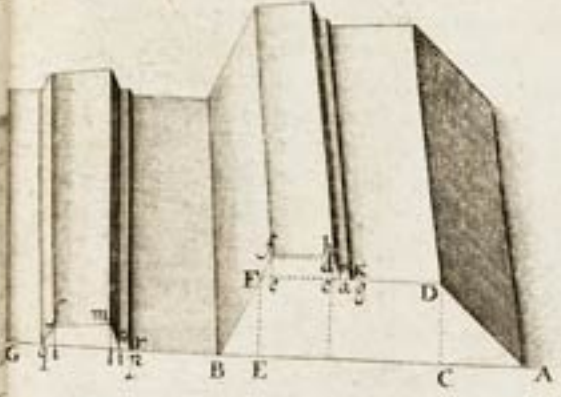
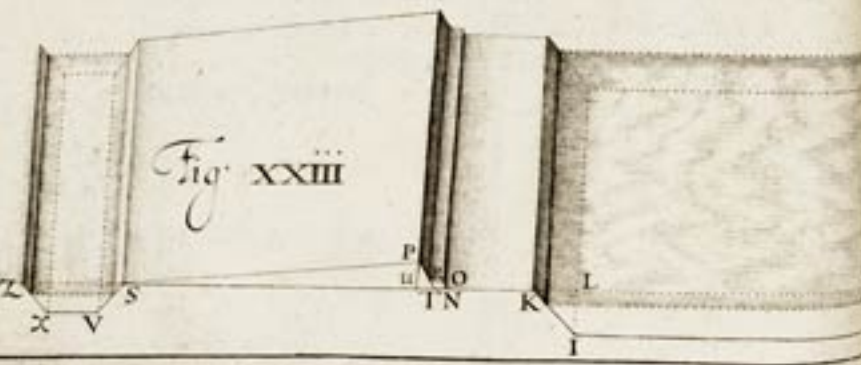
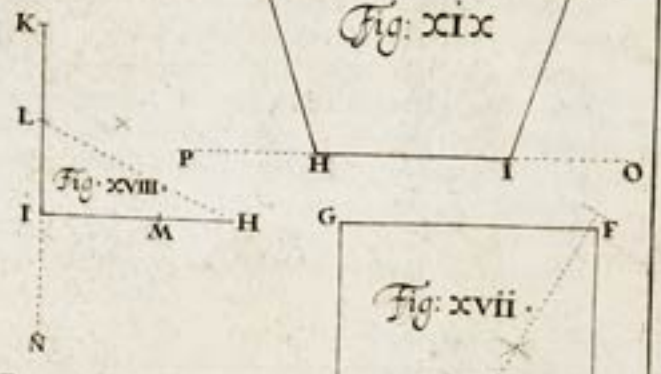
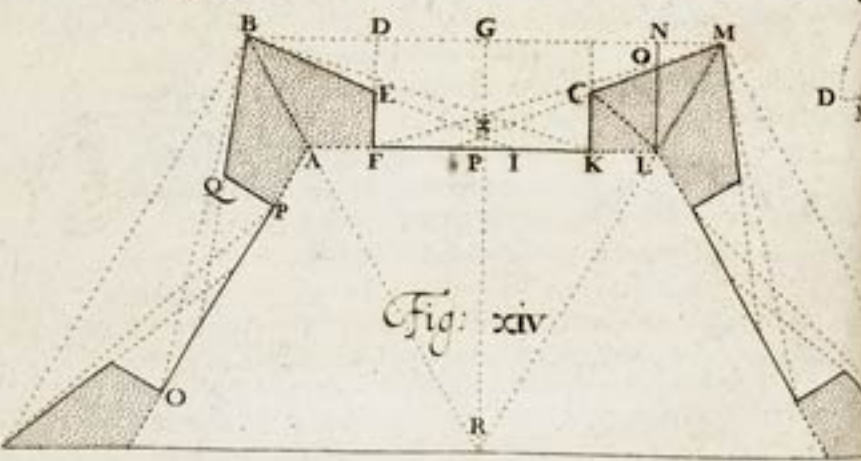
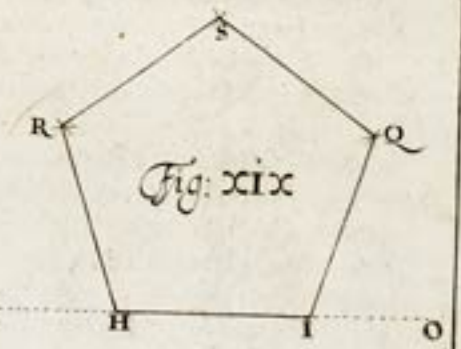



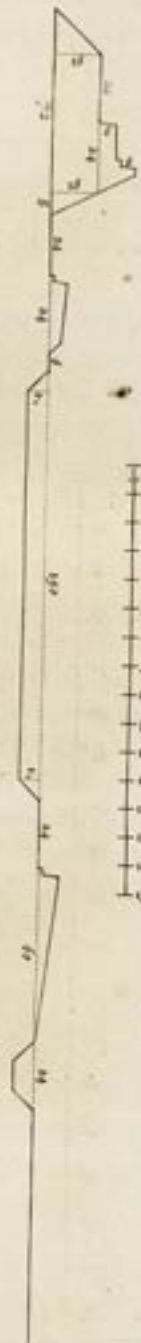
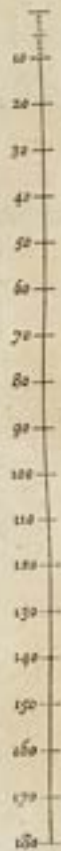
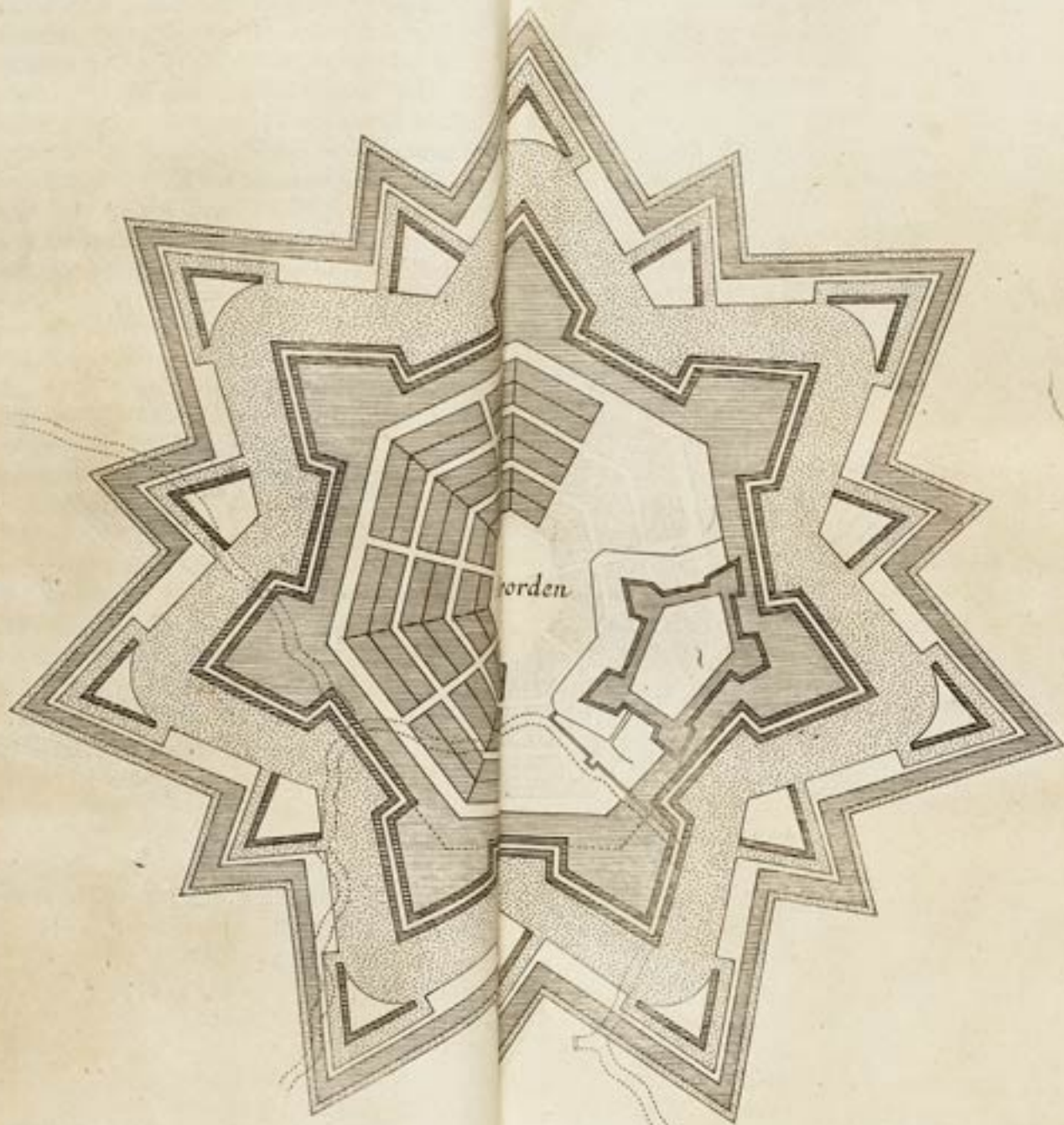



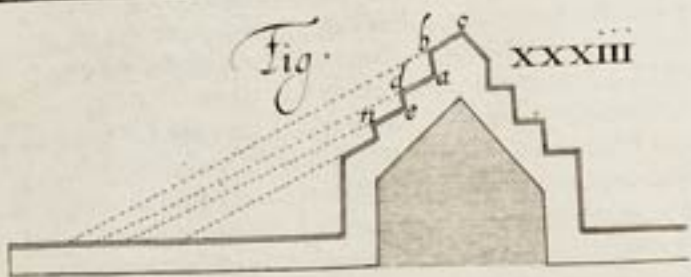

xxvi

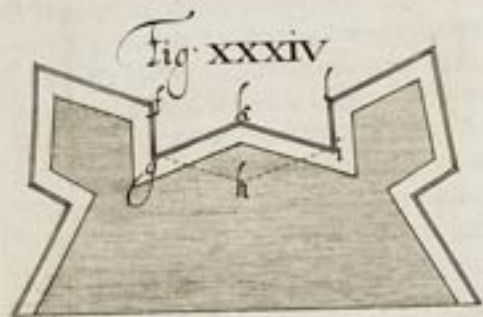
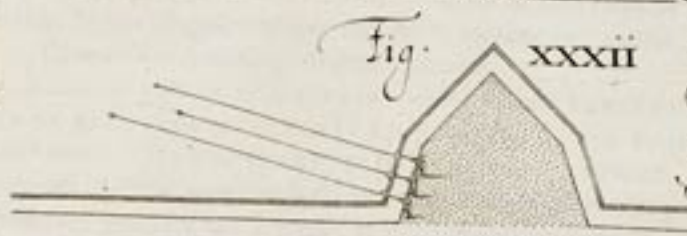
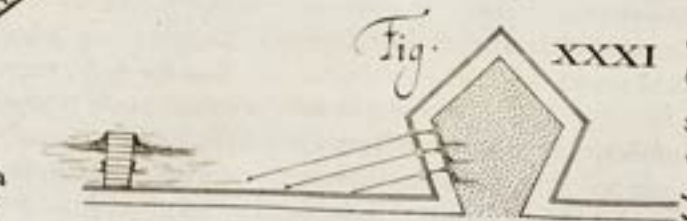
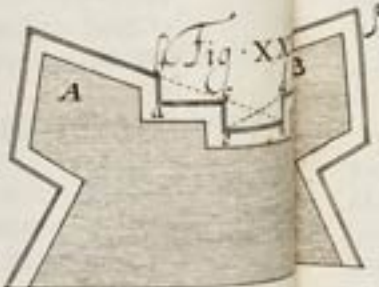
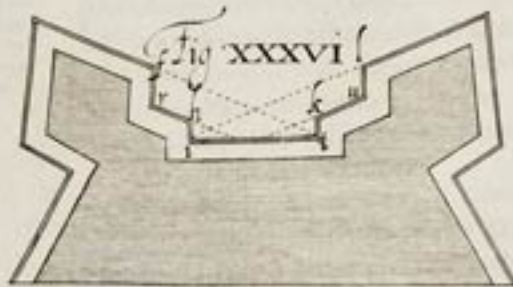
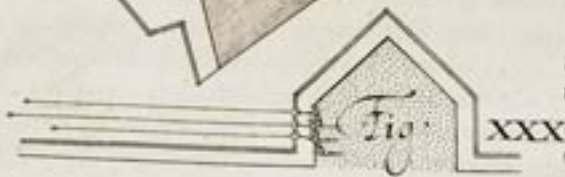
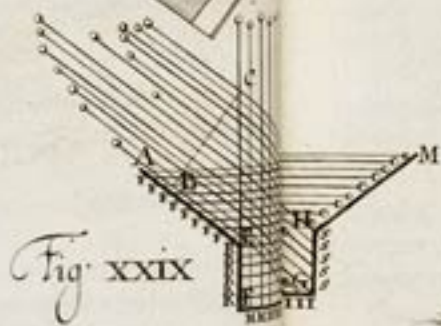

Fig. xxviii



*Semipes Decemalabris Halber Fuß der behusfussigen Kubsten Deminied dela verge de Rhymland diuisee a dix pied*

*Semipes Rhymlandicus Fig. xxv sine duodecimodalabris  
Halber Rheinländerischer Fuß Fig. xxiv Deminied de Rhymland*



Diagrammata Schemographica (Grundtrissen der grossen Festungen  
 Dritter abt Les Plans des Fortereses Royales) MUNITIIONVM MAIORVM  
 Primi muniendi modi



Diagrammata Schemographica (Grundbilder der grossen Festungen  
 Dritter abt Les Plans des Fortereses Royales) MUNITIIONVM MAIORVM  
 quarum Egens factum Musquettae aequat  
 Terti modi

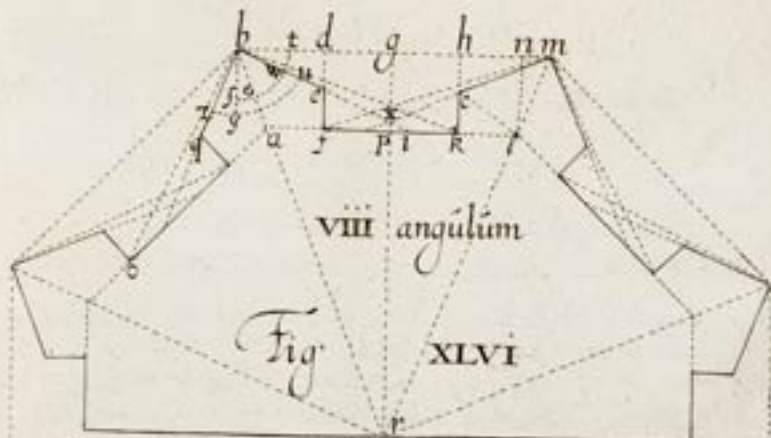
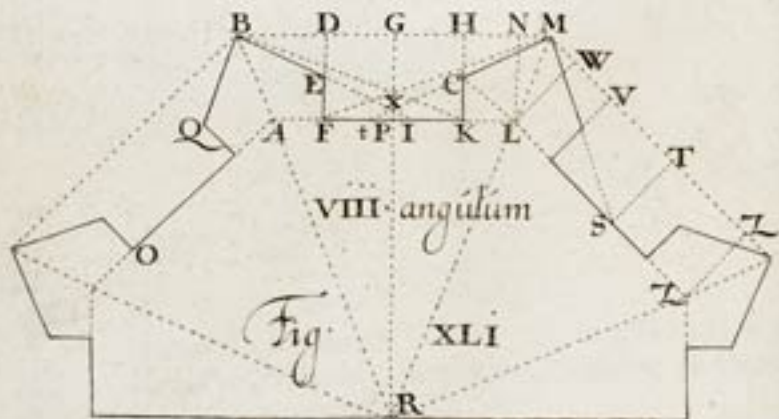
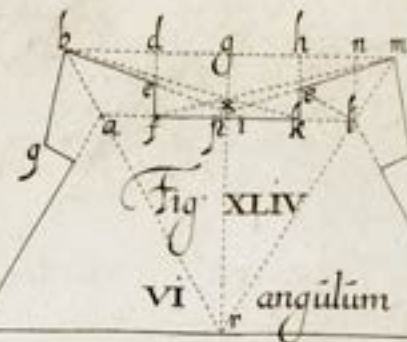
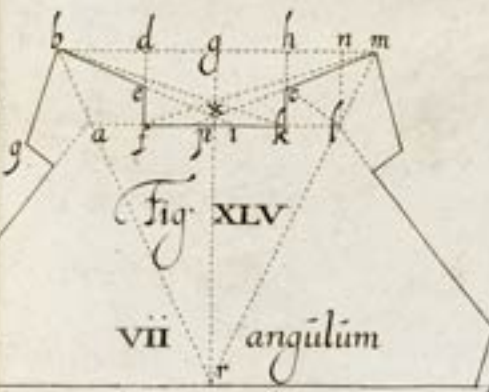
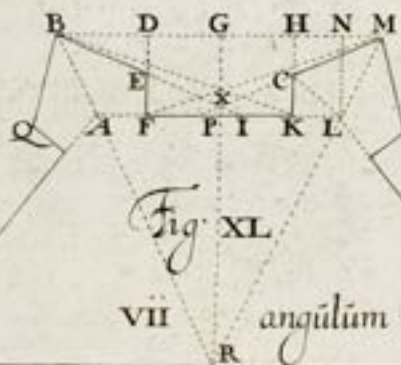
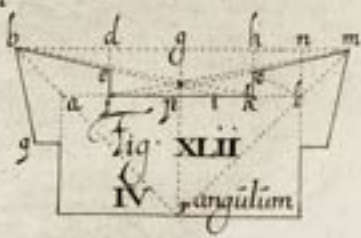



Diagrammata Ichnographica (Grundrisse der Kleinen Festungen)  
 Erster arbt Les Plans des Fortereses) MUNITIONVM MINORVM  
 quarum Propugnacula ad iactum Musquettae distant  
 Primi modi

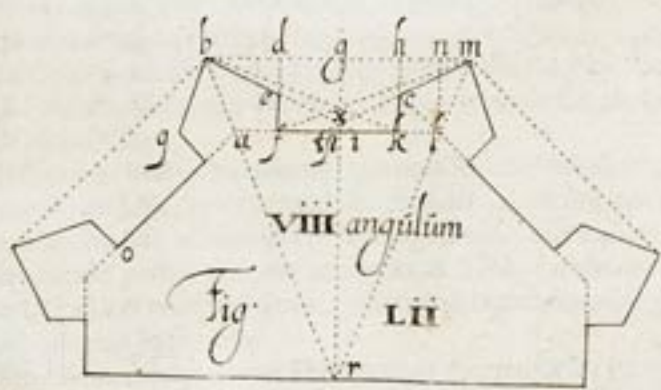
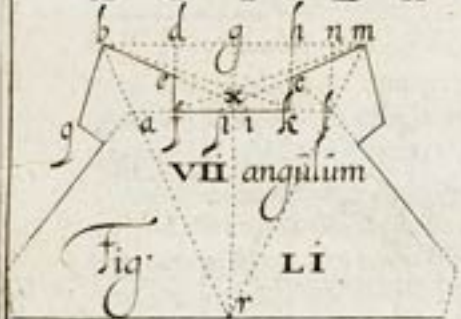
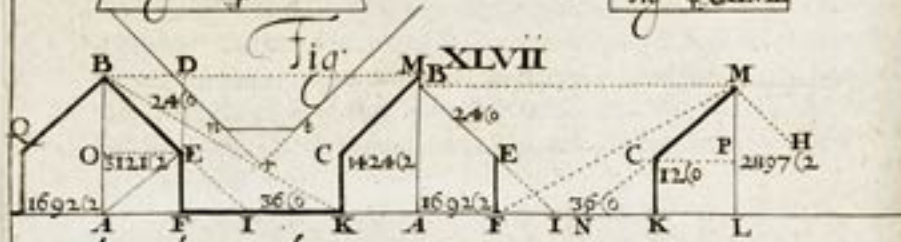

Diagrammata Ichnographica (Grundrisse der Kleinen Festungen)  
 Dritter arbt Les Plans des Fortereses) MUNITIONVM  
 MINORVM quarum Propugnacula LX Decemmedas distant Tertij modi

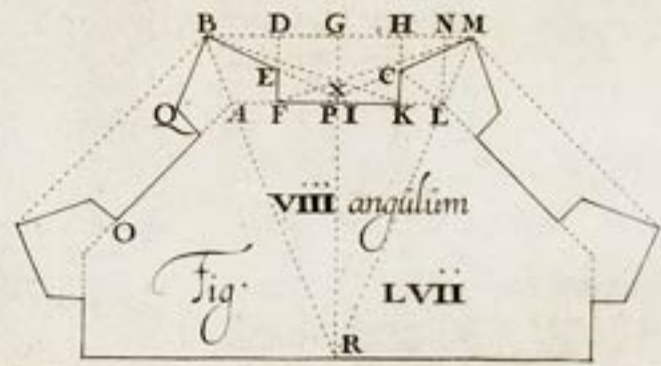



Diagrammata Munimentorum Orthographica

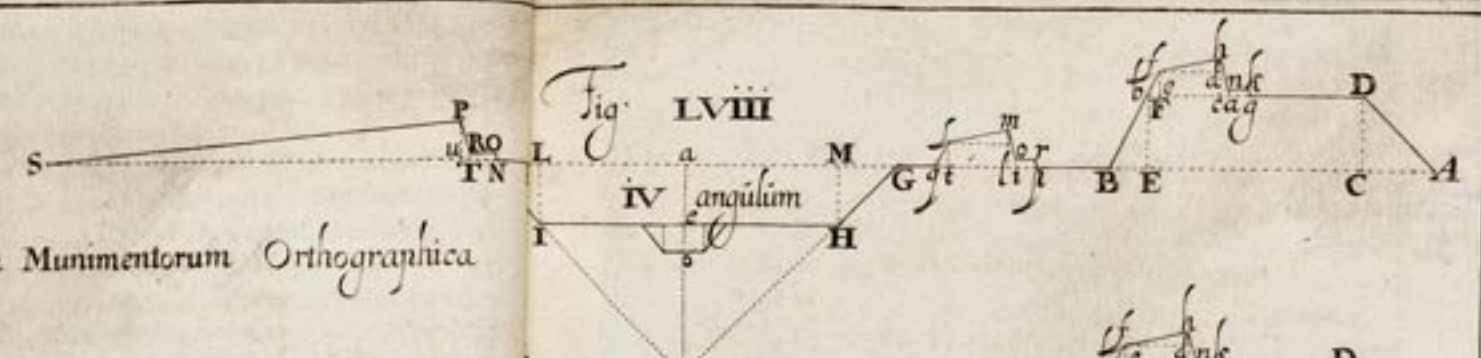

Schnitt Stadtbilder der Festungen



Les Profils des Tortereses

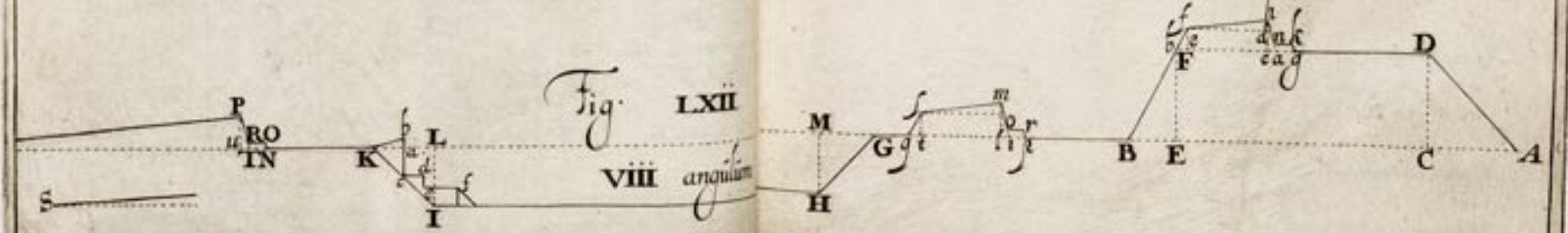
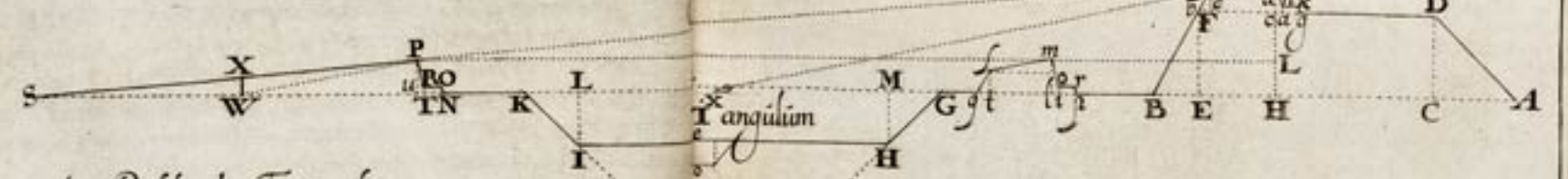



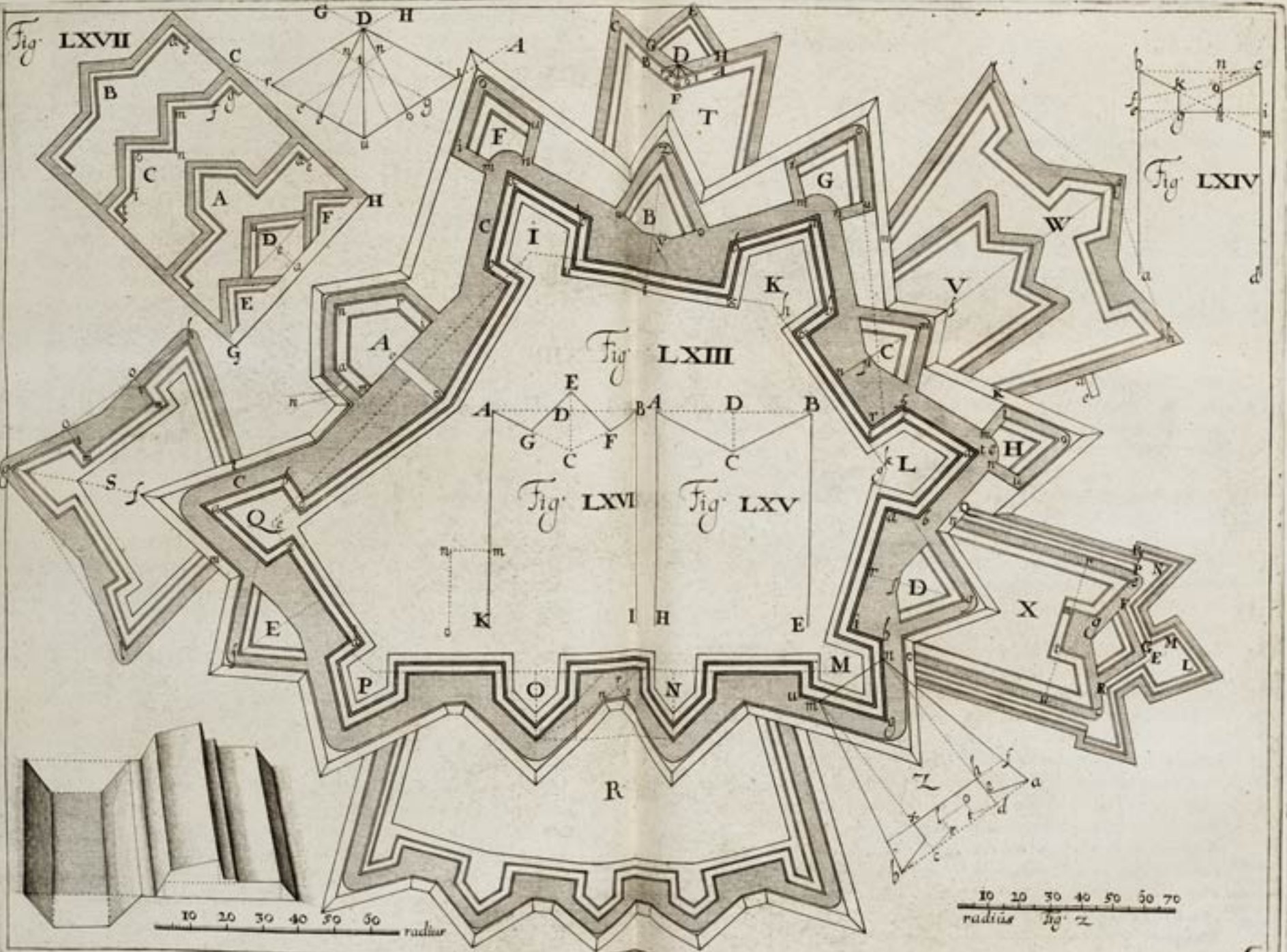



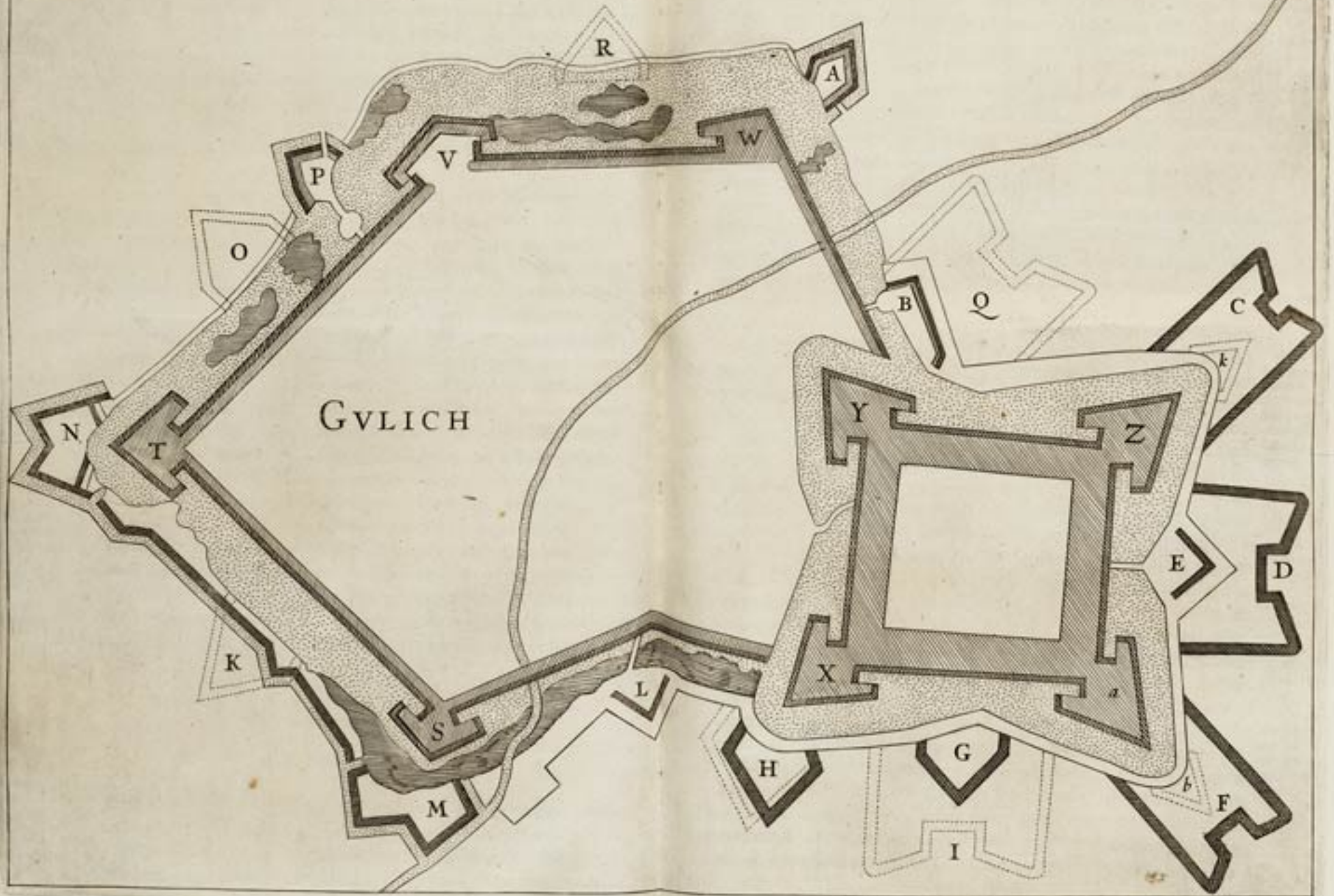
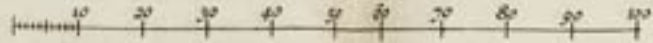

GVLICH

R

A

W

V

P

O

B

Q

C

N

T

k

K

E

D

S

L

X

a

M

H

G

F

I

b







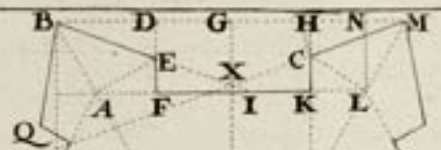

Fig. LXXIX

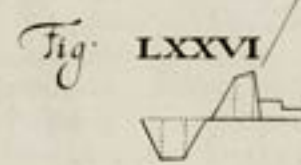

Fig. LXXVI

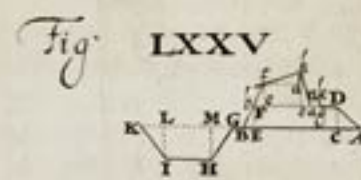

Fig. LXXV

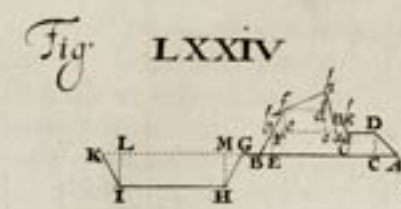

Fig. LXXIV

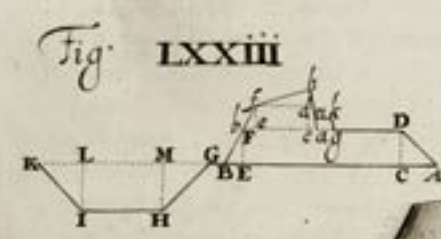

Fig. LXXIII

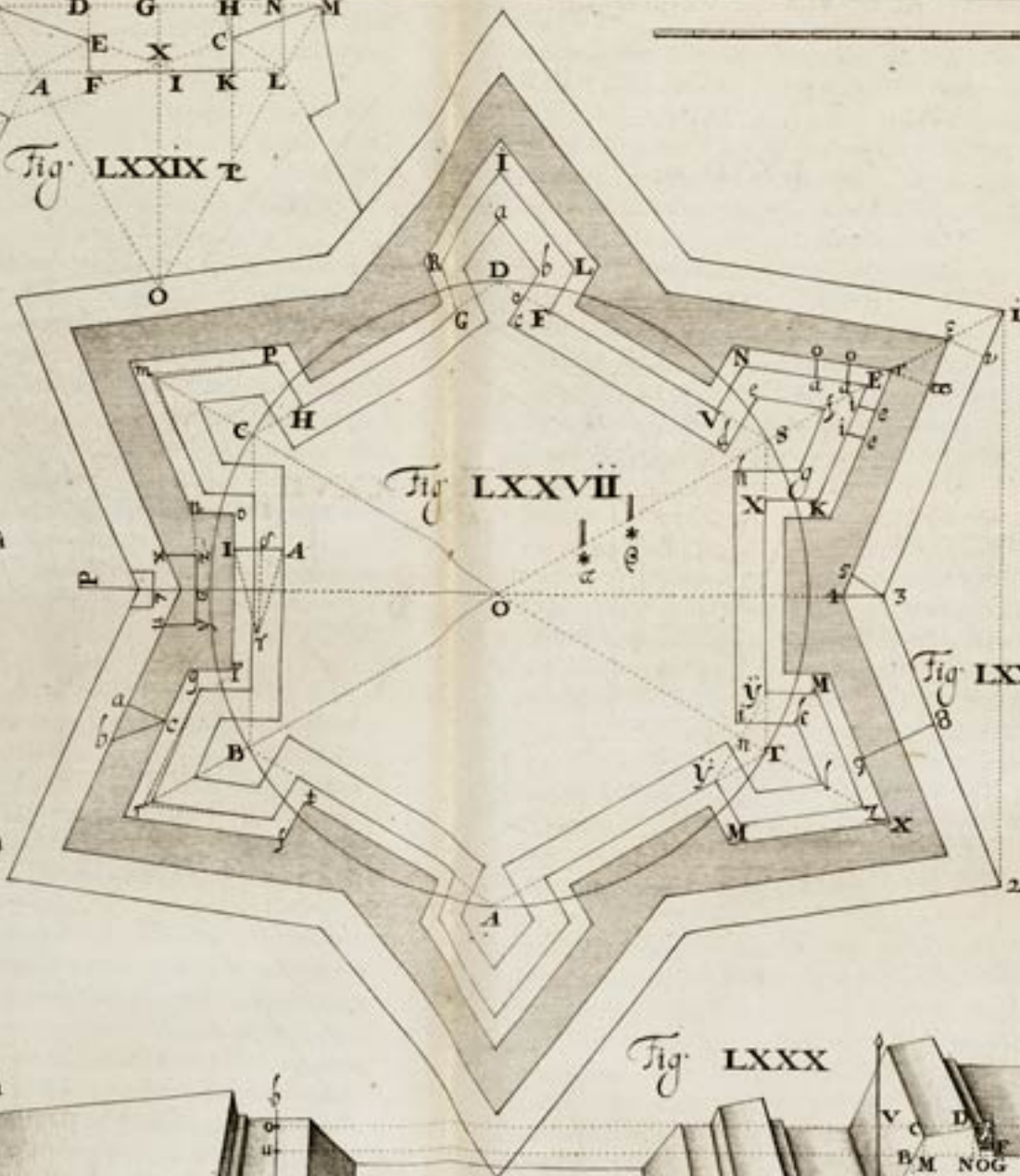

Fig. LXXVII

Fig. LXXVIII

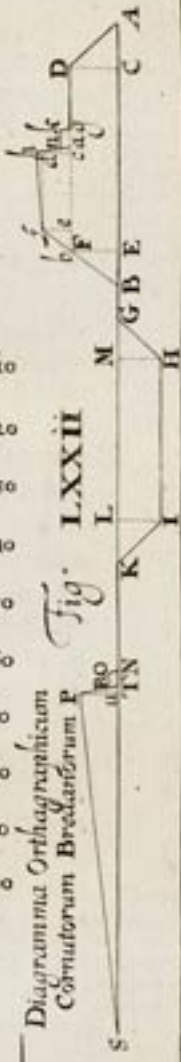
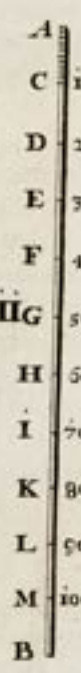

Fig. LXXII

Diagramma Orthognomicum  
Carnuorum Breclanzorum P.



Fig. LXXX

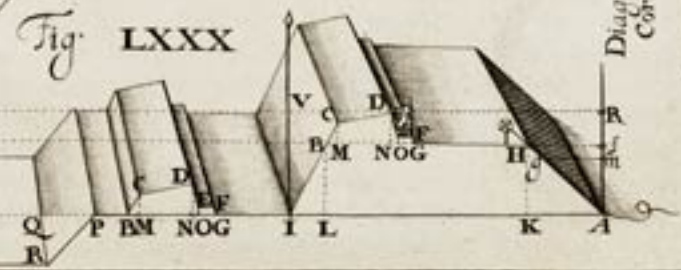



Fig. LXXXIV

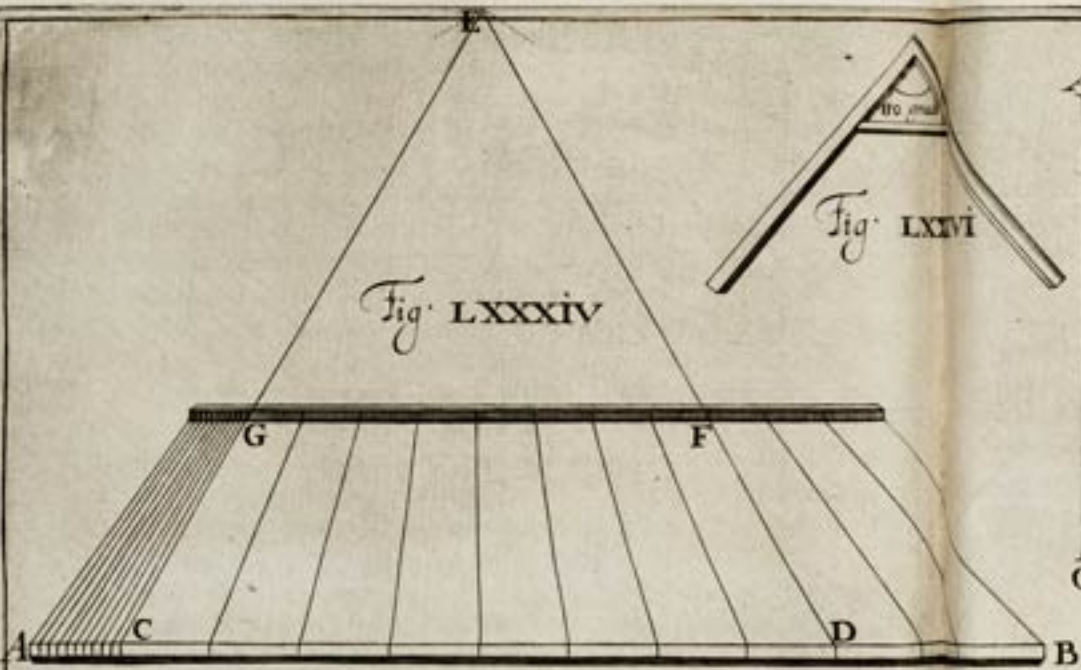

Fig. LXXVI



A  
O  
E  
y

Fig. LXXXI

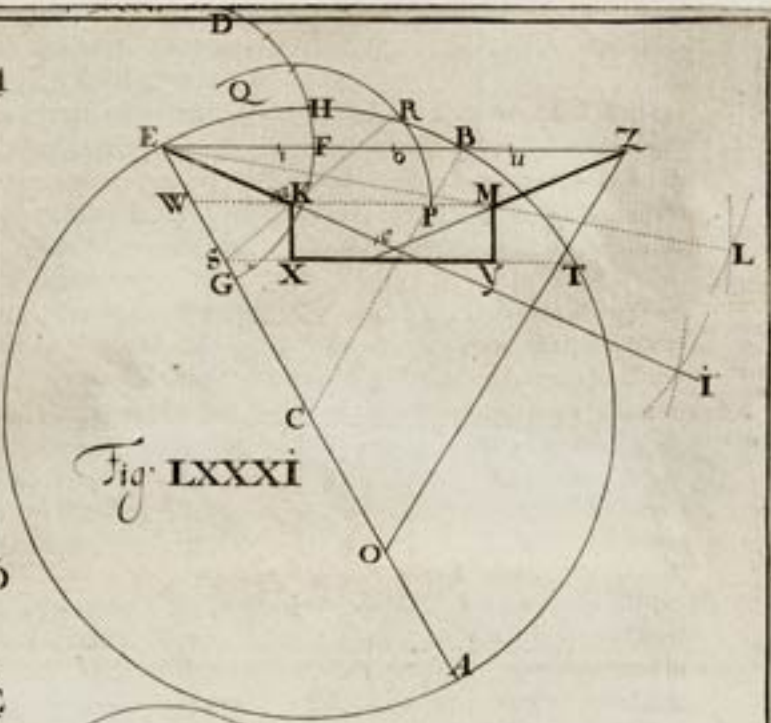

Fig. LXXXV

D	a	b	c	d	e	f	g	h	i	A
O										E
R	1	2	3	4	5	6	7	8	9	F
S	u									G
										H
										I
										K
										L
										M
										N
C	k	l	m	n	o	p	q	r	j	B

Fig. LXXXIII

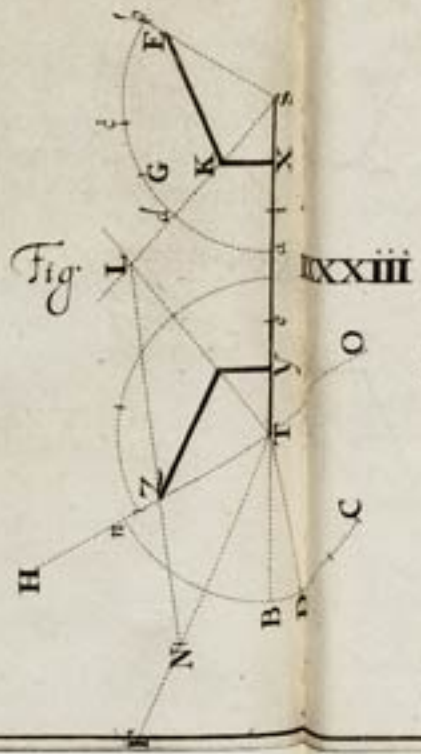
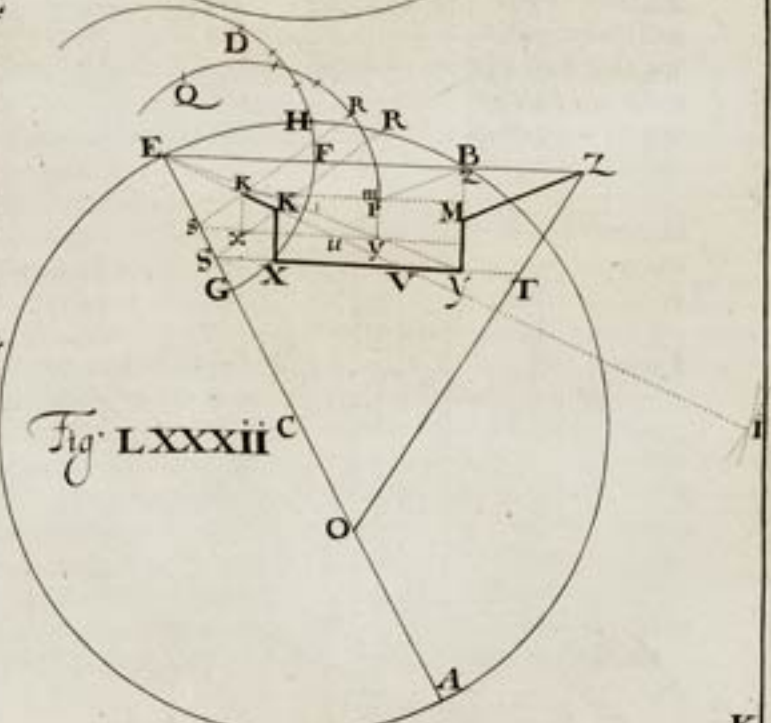
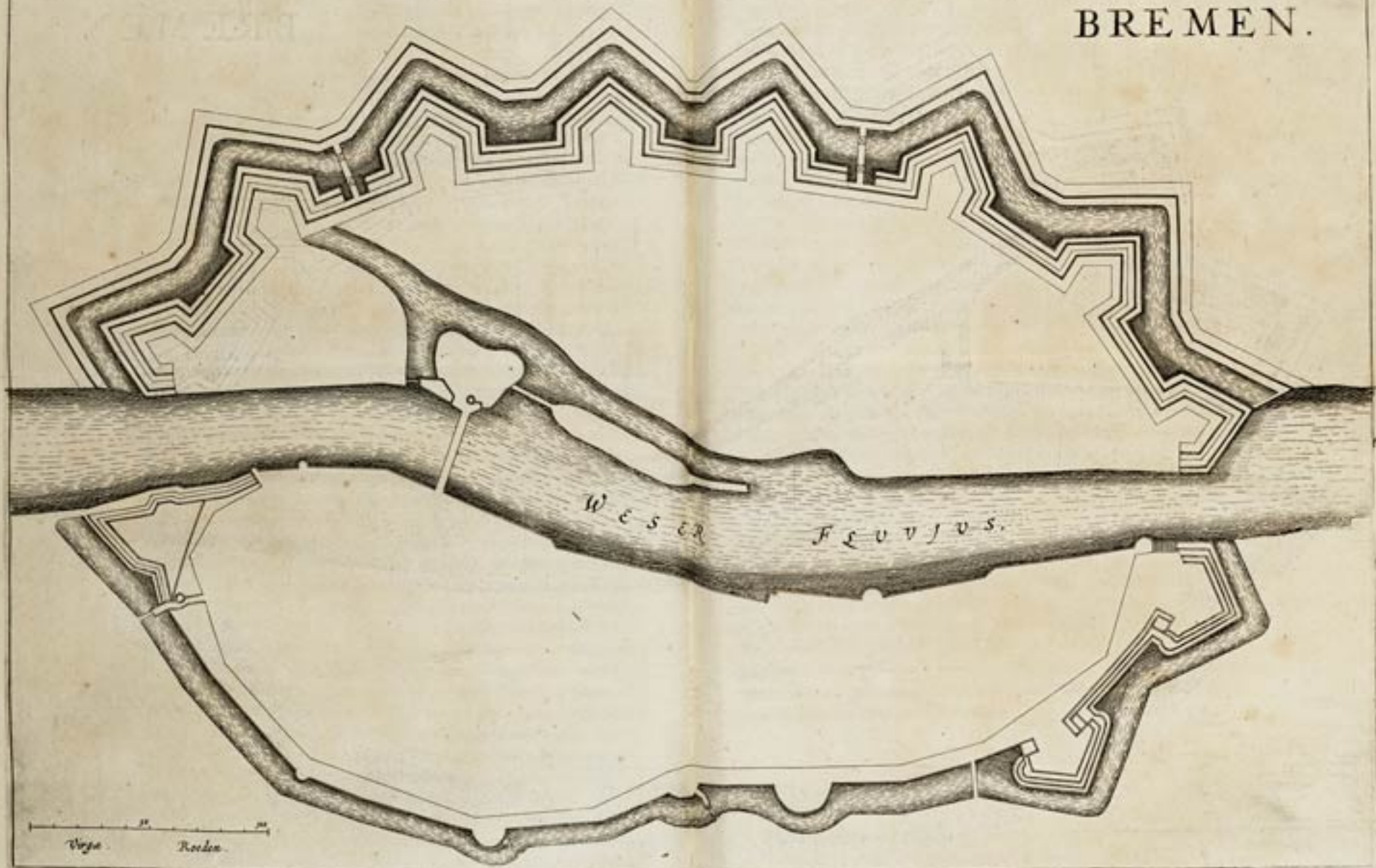

Fig. LXXXII





BREMEN.





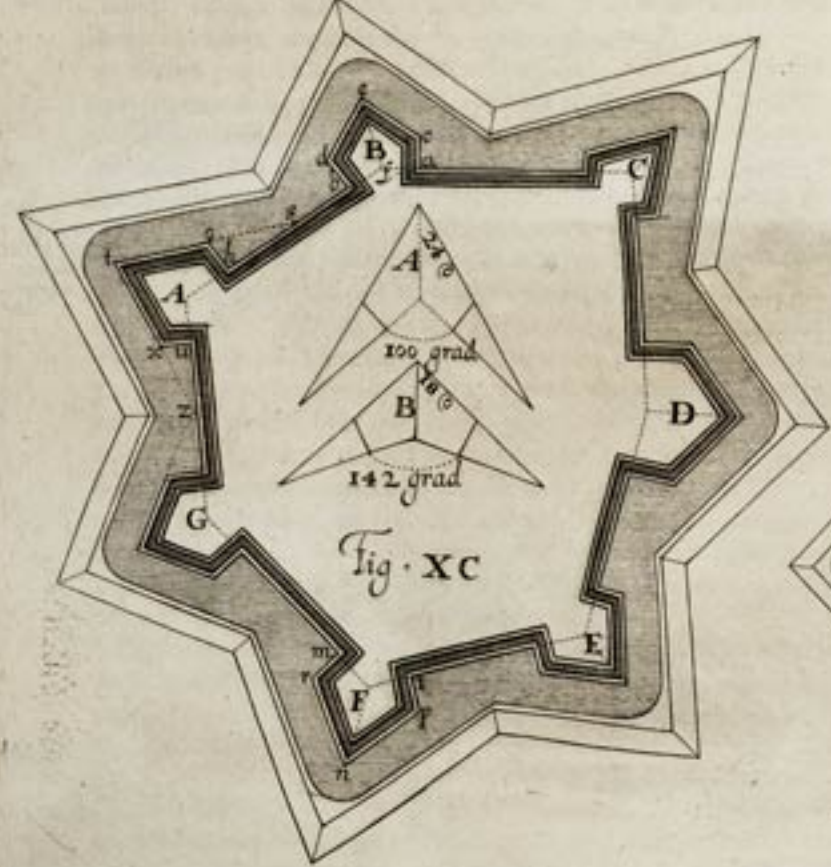
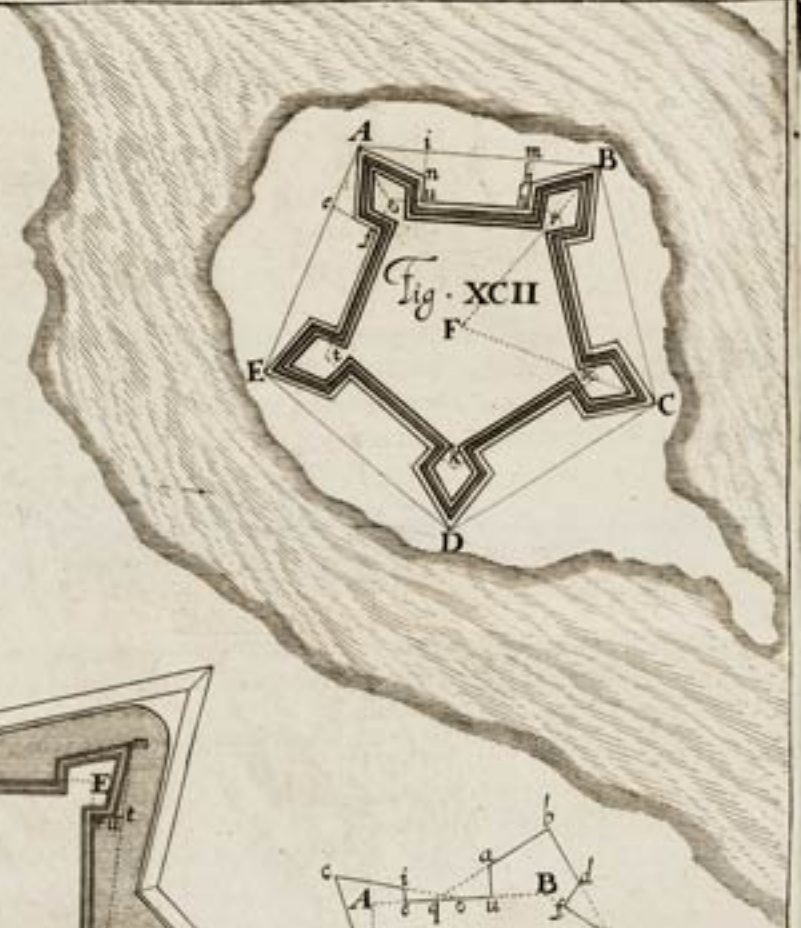

L



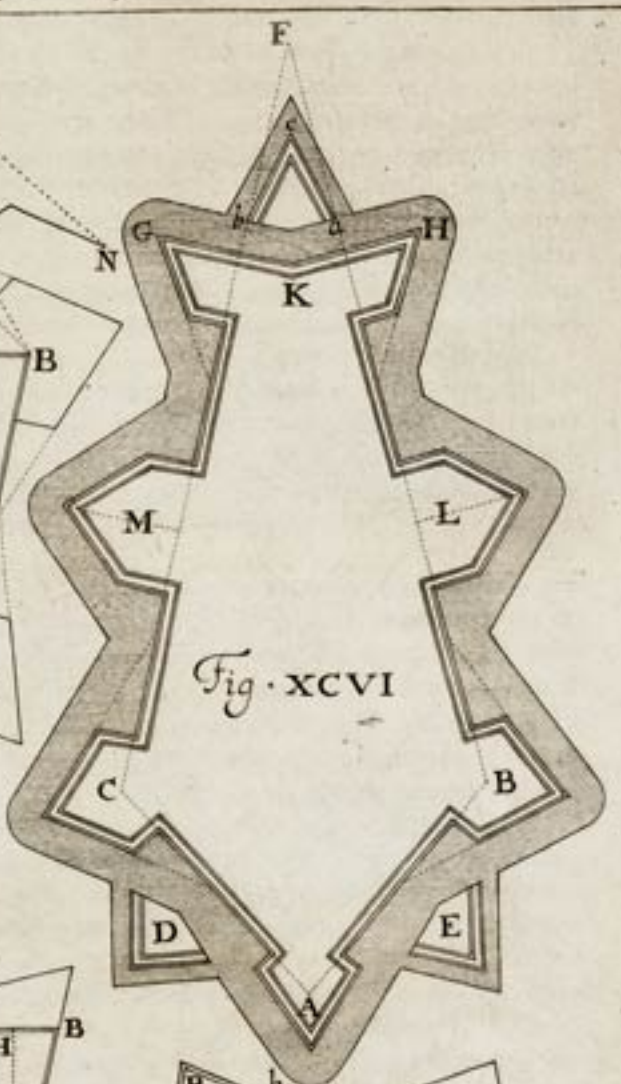
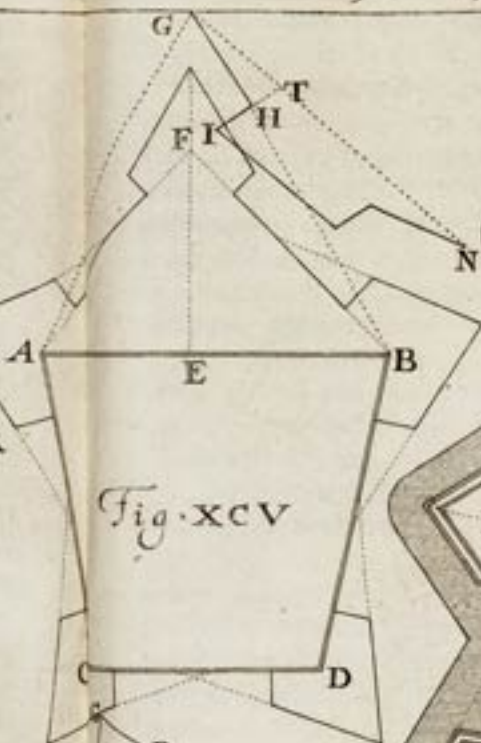
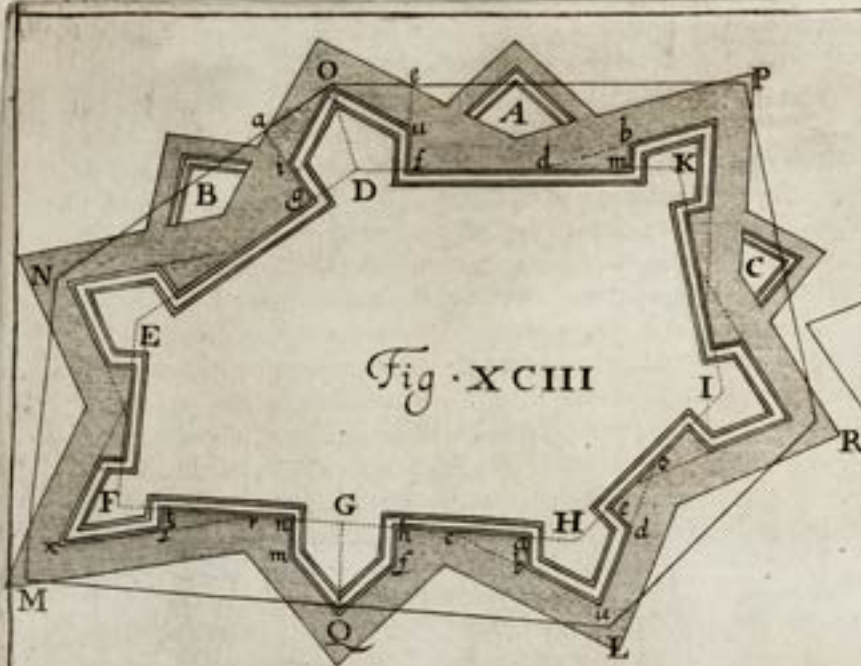

M



WINSCHOTEN

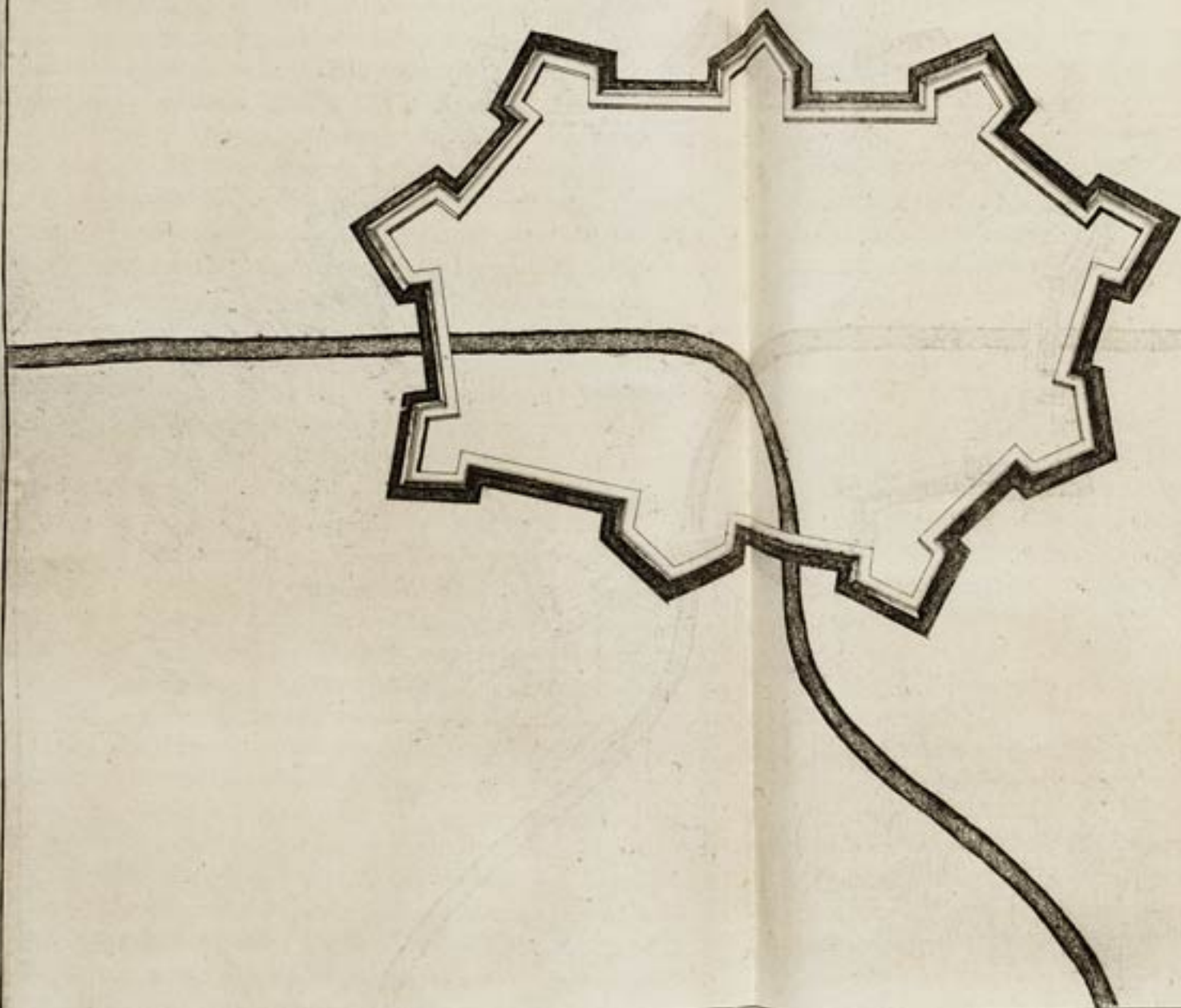



CREVECŒVR.

Voys. Reclin.

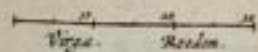

M O S A F E V.

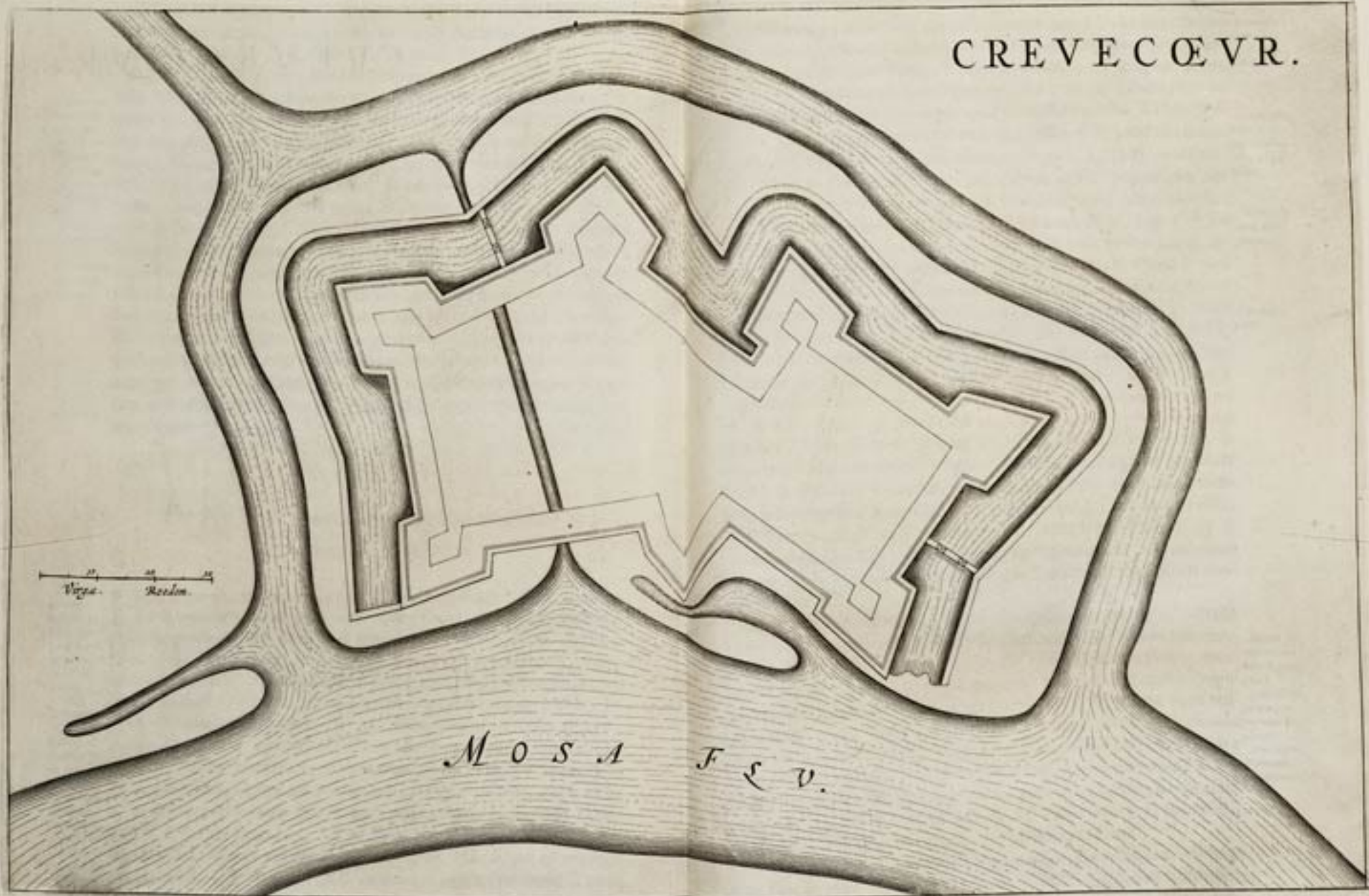



LIEROORT.

LÆDA FLV. *vulgo* SAGE.

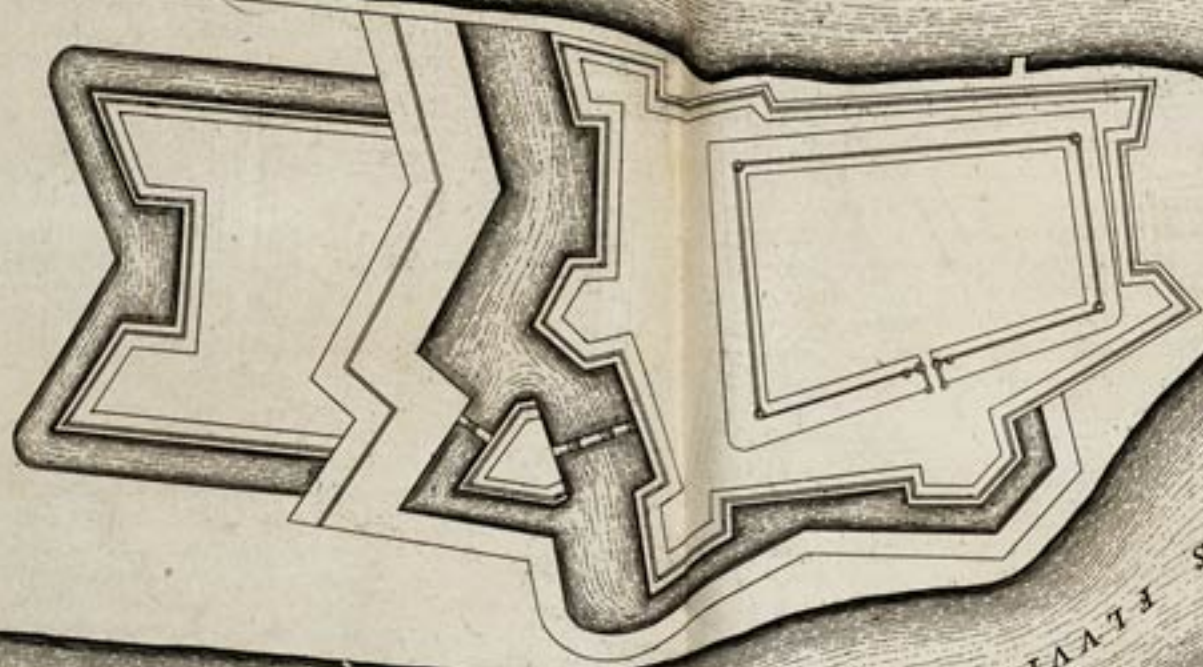

AMASIS FLUVIUS

*vulgo* DE CENSE.

10 20 30  
Vige Rhodanie.



ZVTPHEN.

De Yssee.

Moeras.

Moeras.

Moeras.

Vijve Roden.

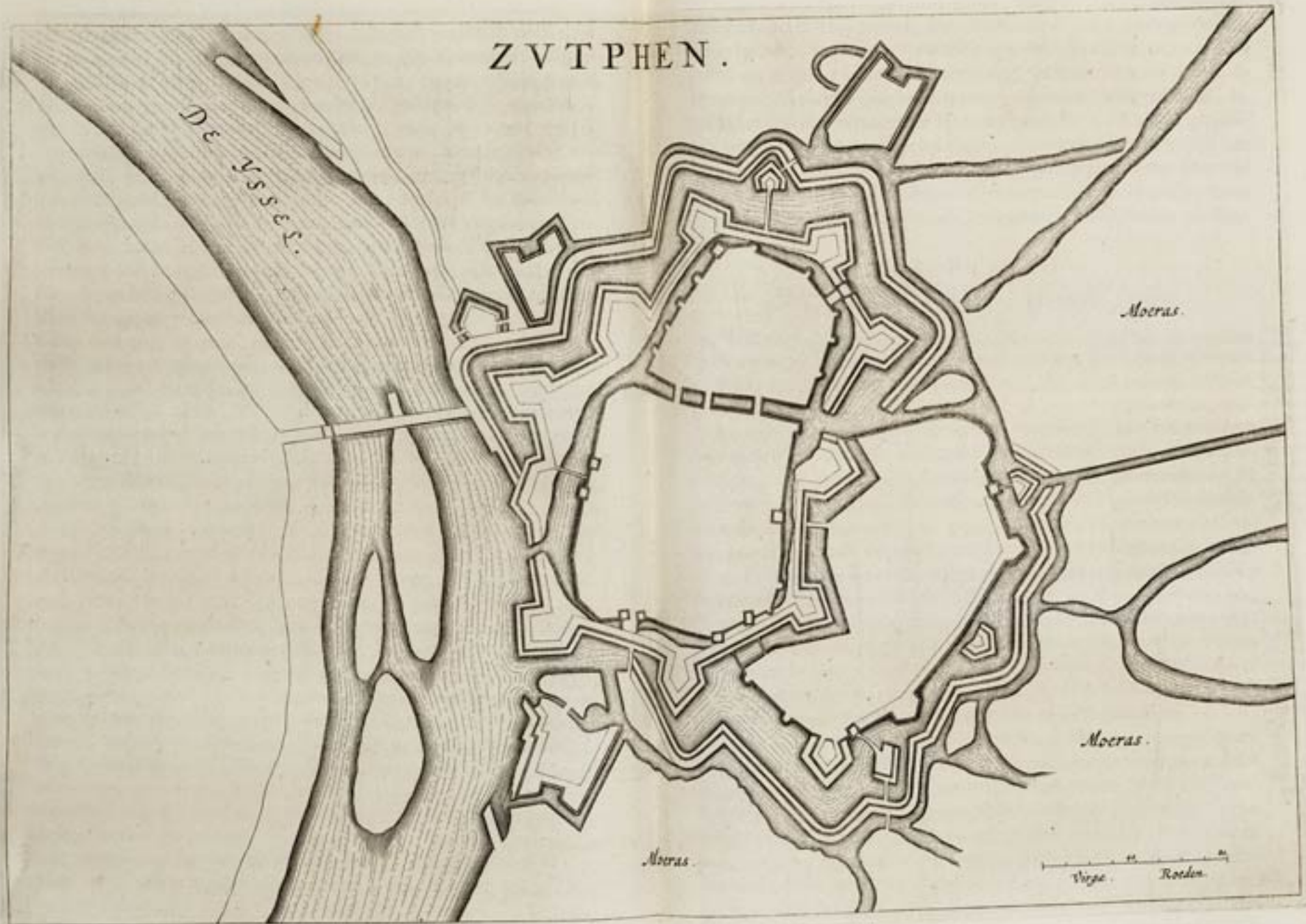



DEVENTER.

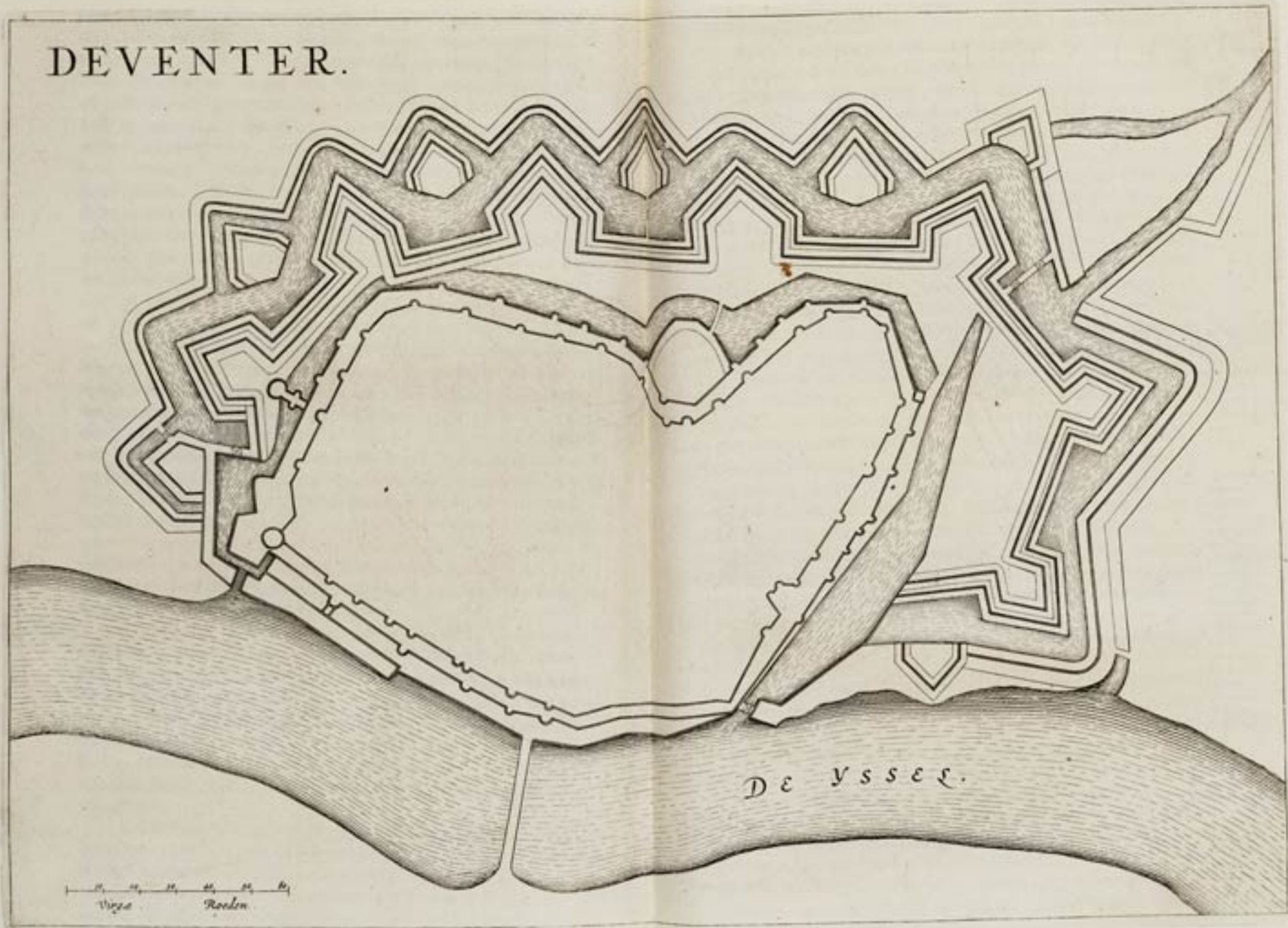

DE YSSEL.

0 10 20 30 40 50  
Vijze Roelen



Fig. C

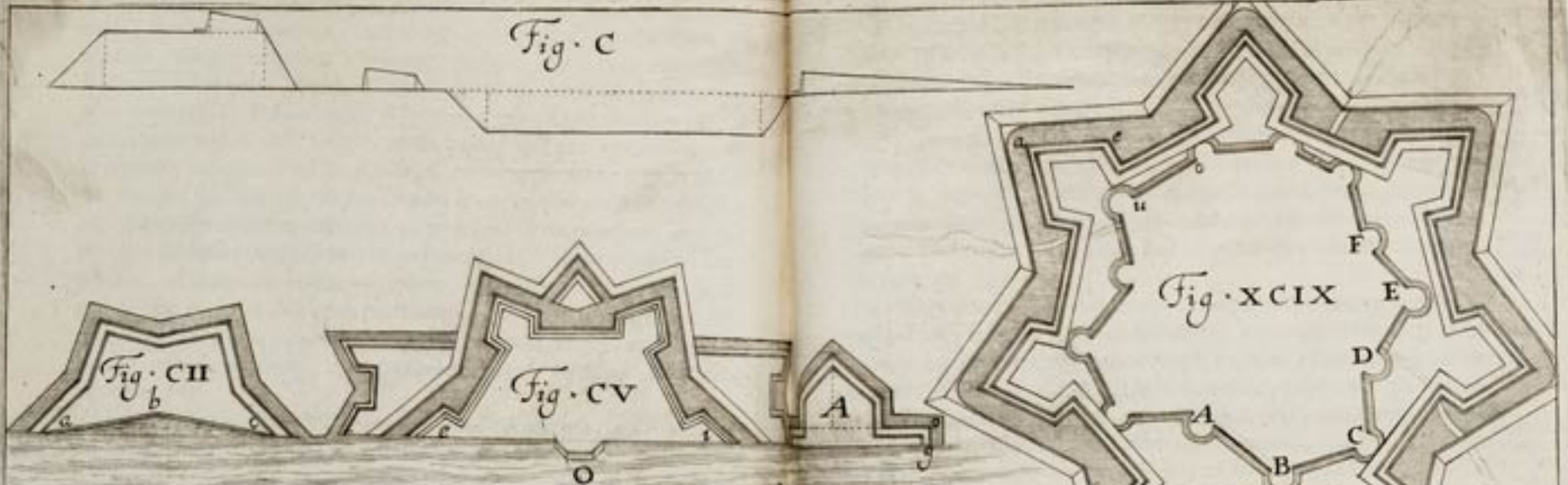

Fig. XCIX



Fig. CV



Fig. CII



Fig. CIII



Fig. CI

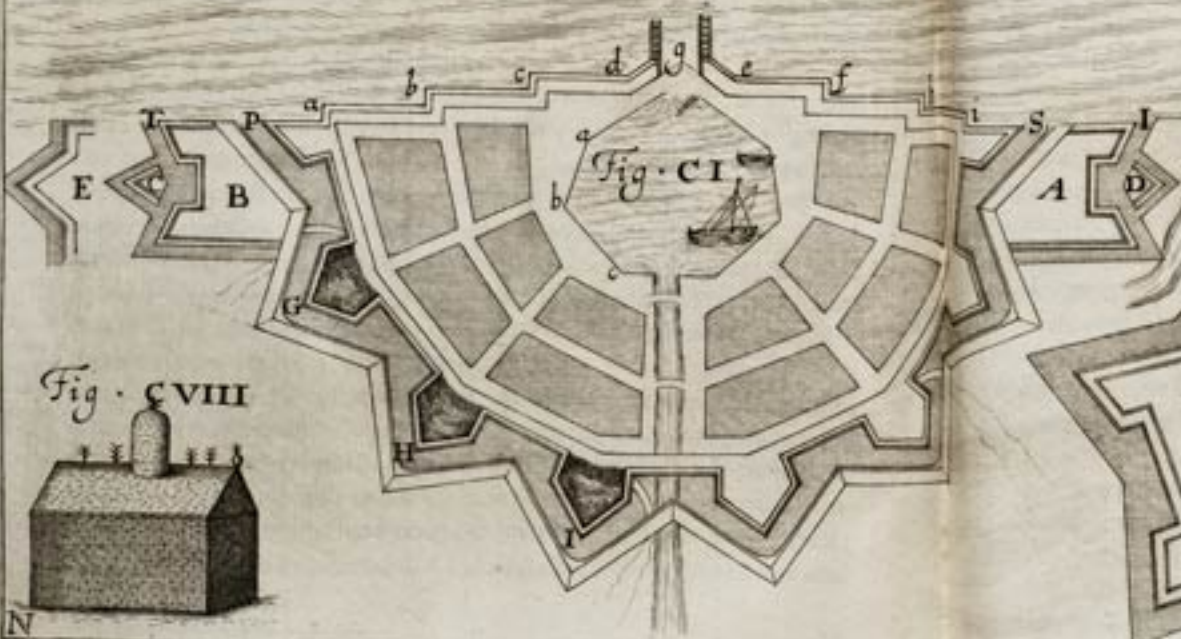

Fig. CVIII



Fig. CIV



Fig. CVI

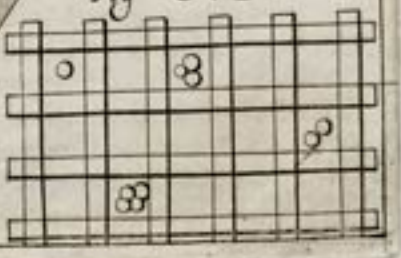



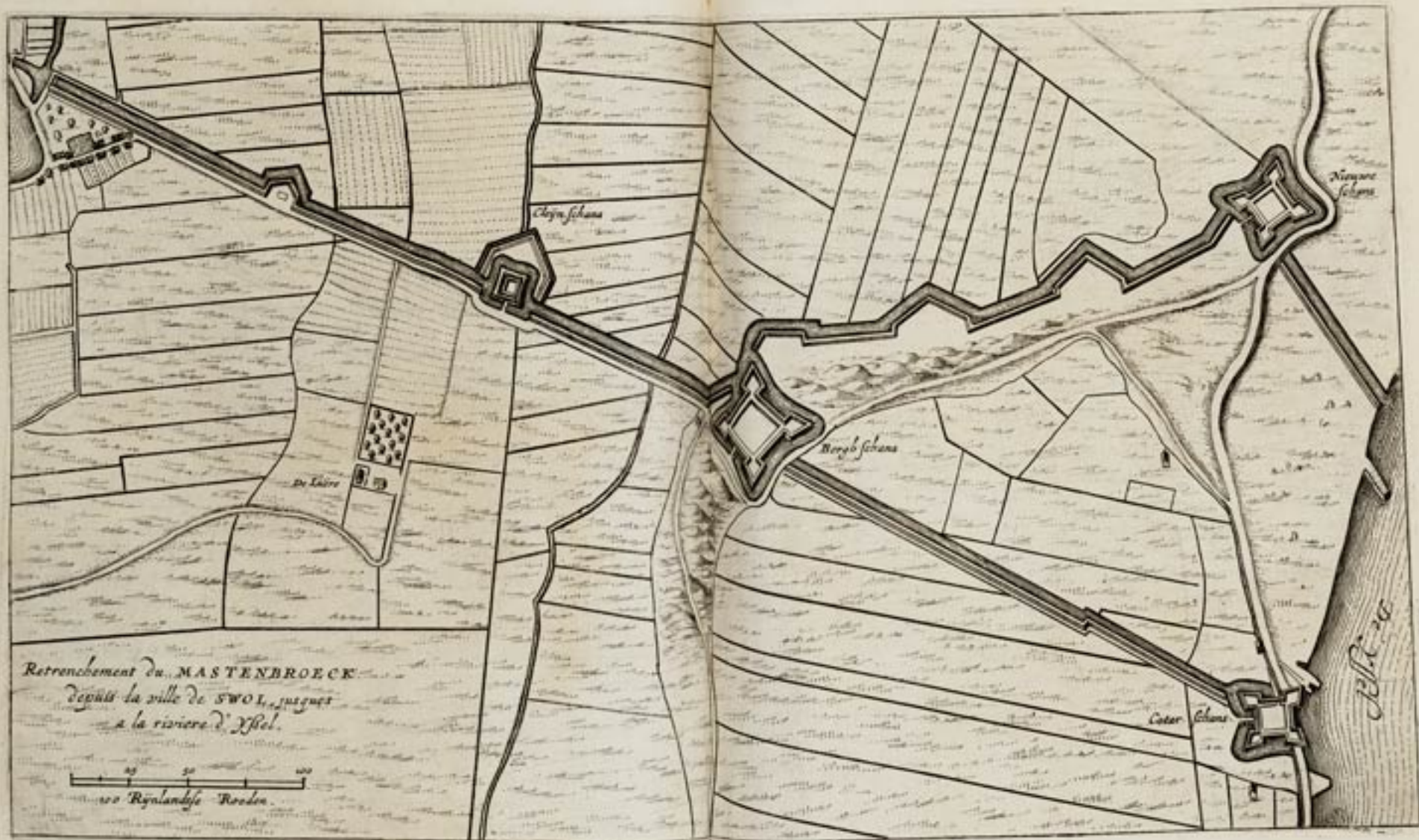

Retrenchement du MASTENBROECK  
depuis la ville de SWOL, jusques  
à la rivière d'Yssel.

0 50 100  
100 Rijlandse Roeden.



SWOL.

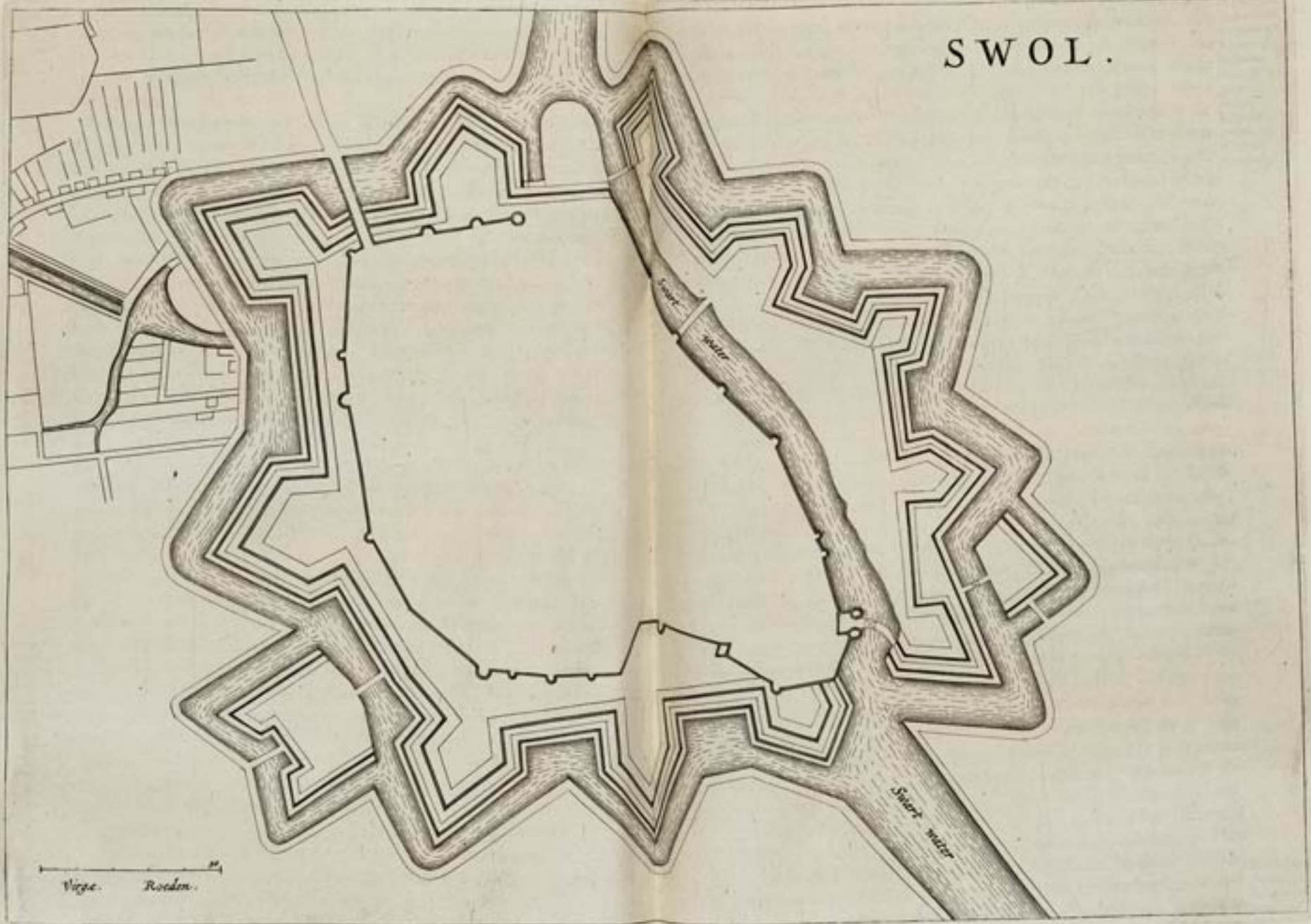

Vijge. Roeden. M



GOES.

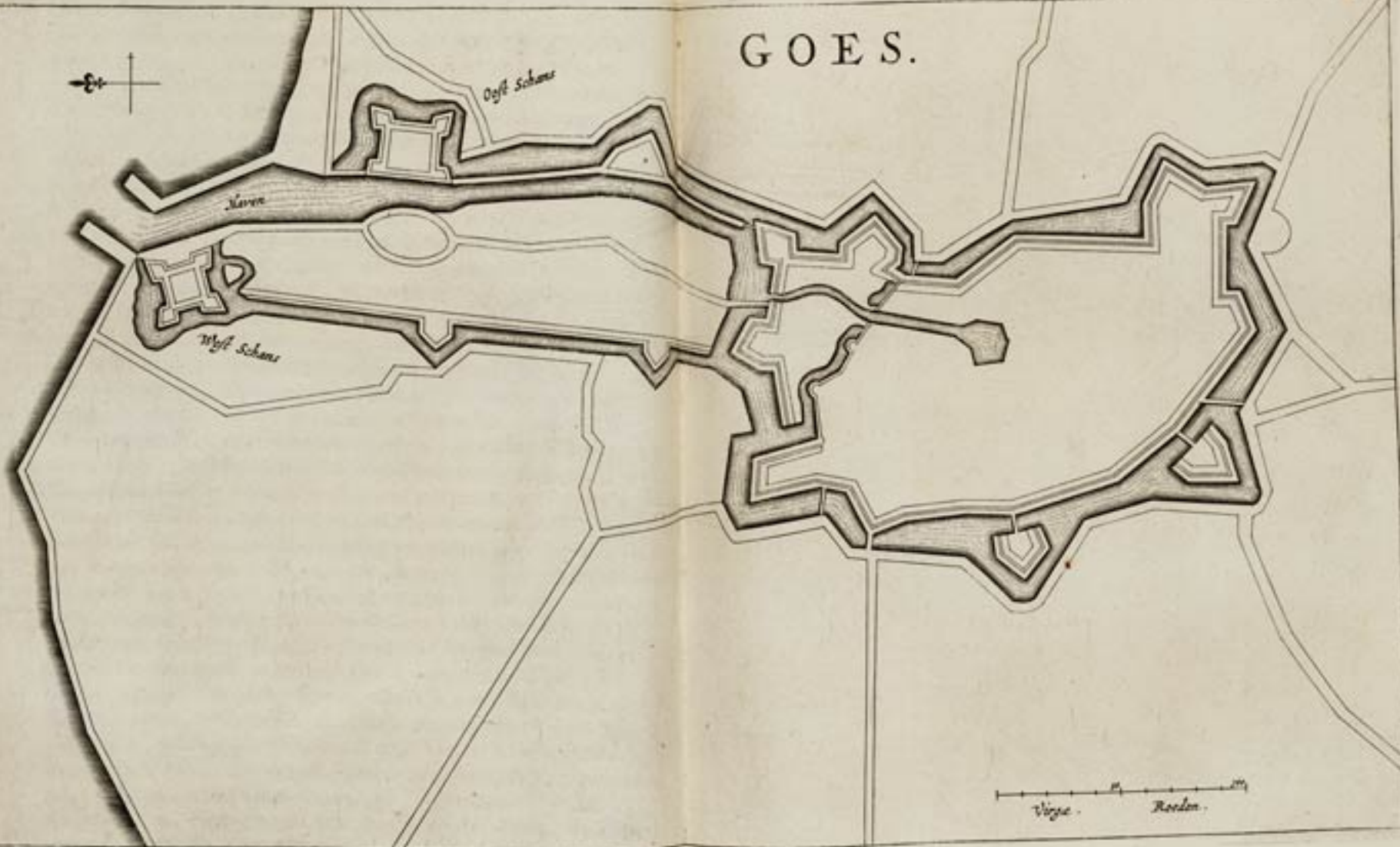
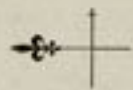

Naven

Oefft Schans

Wyl Schans

Vijge . . . . . Roeden .



MANHEIM.

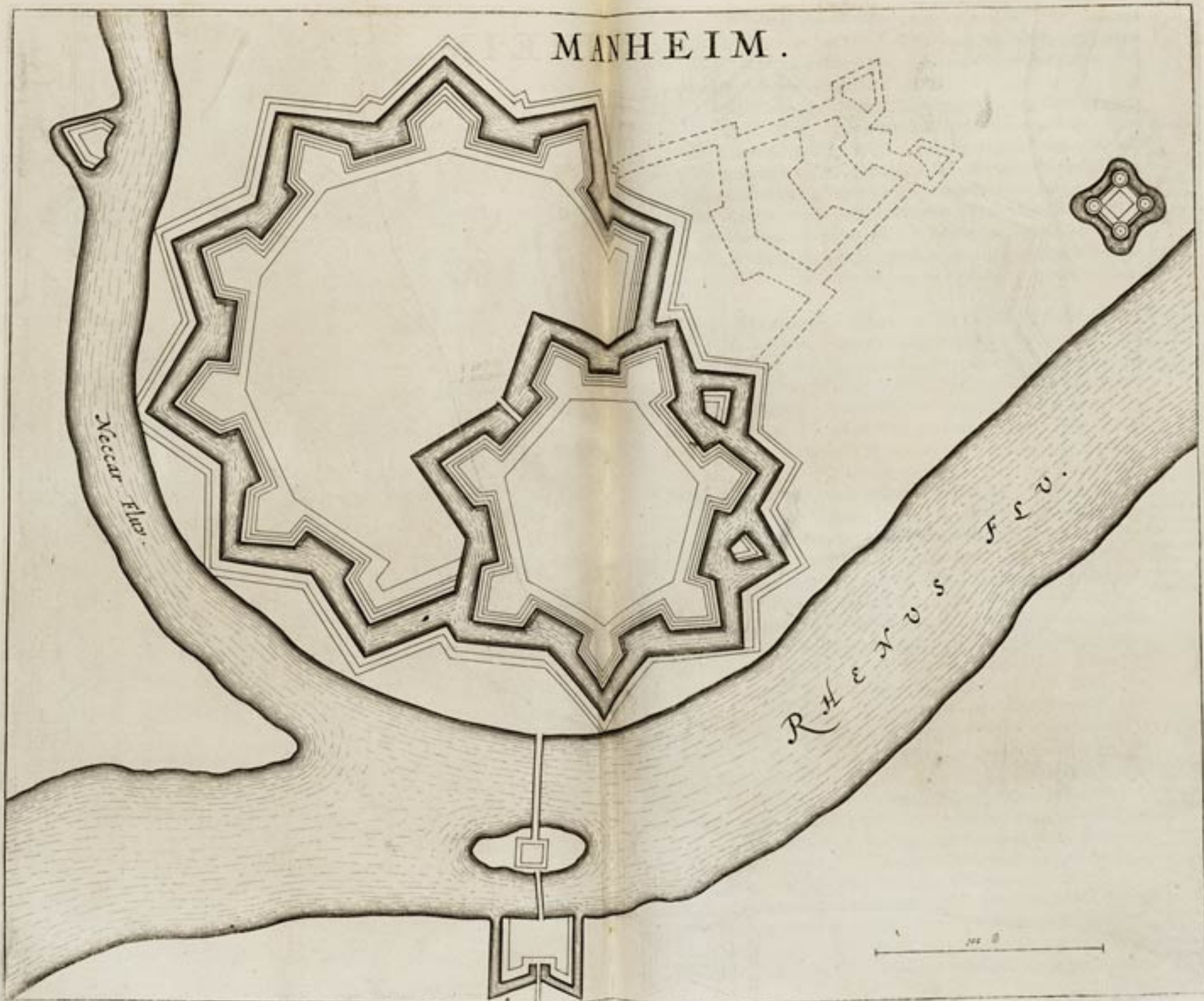

ORANGE.

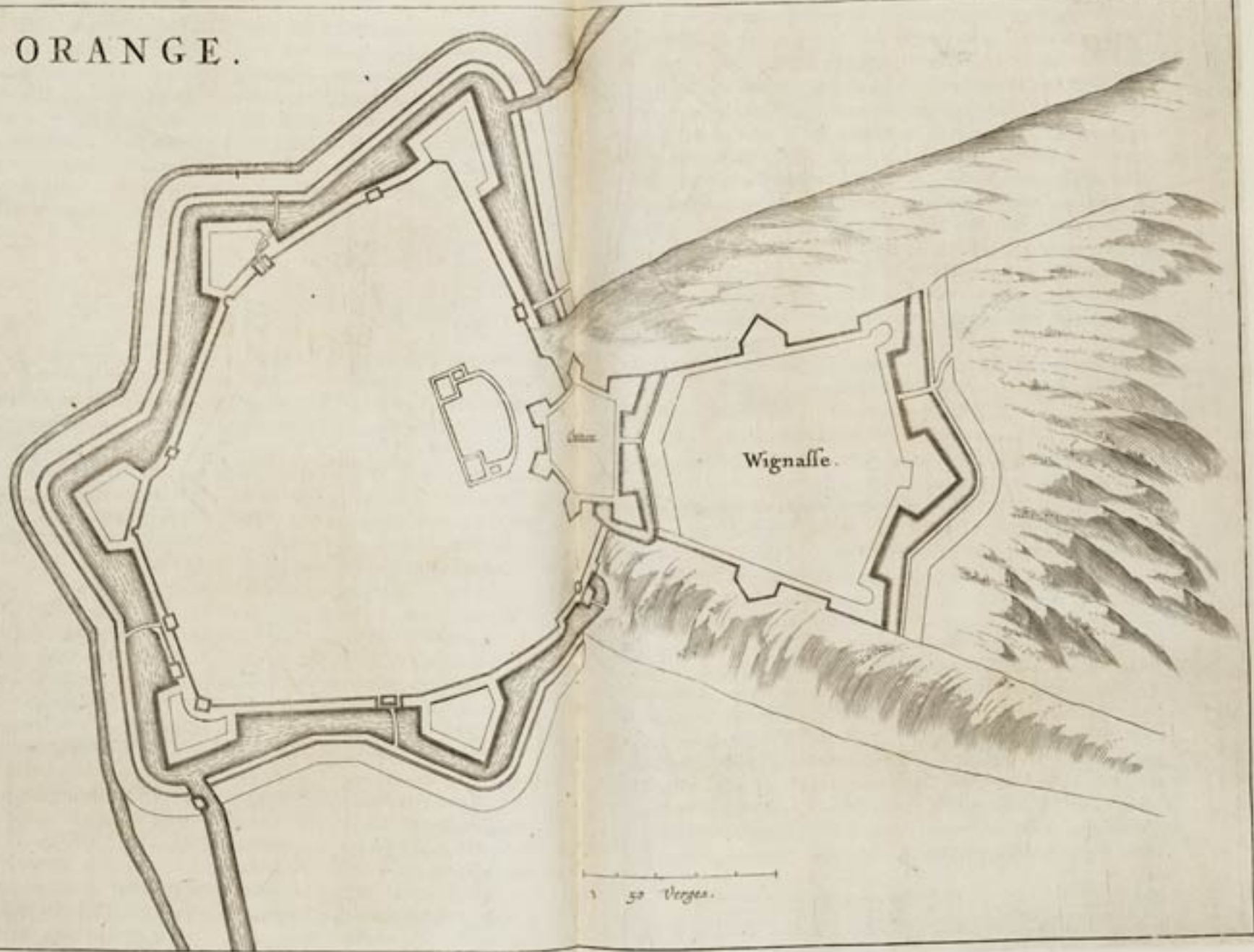

50 Verges.



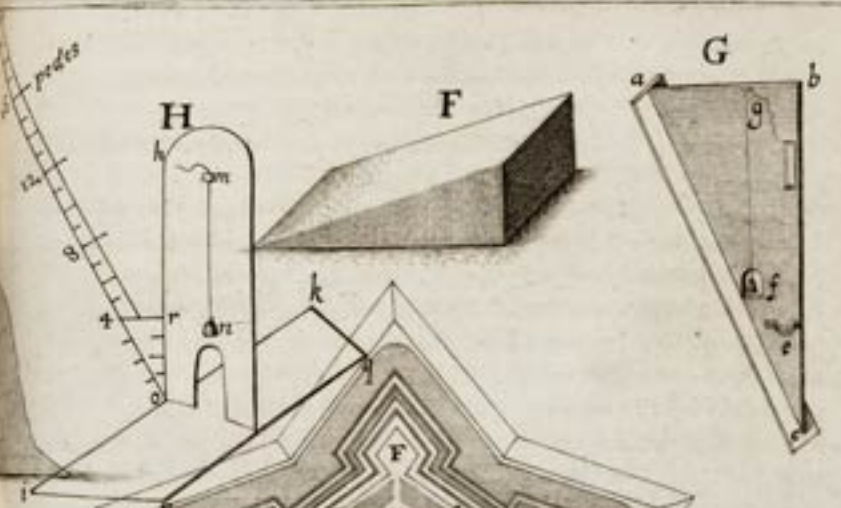
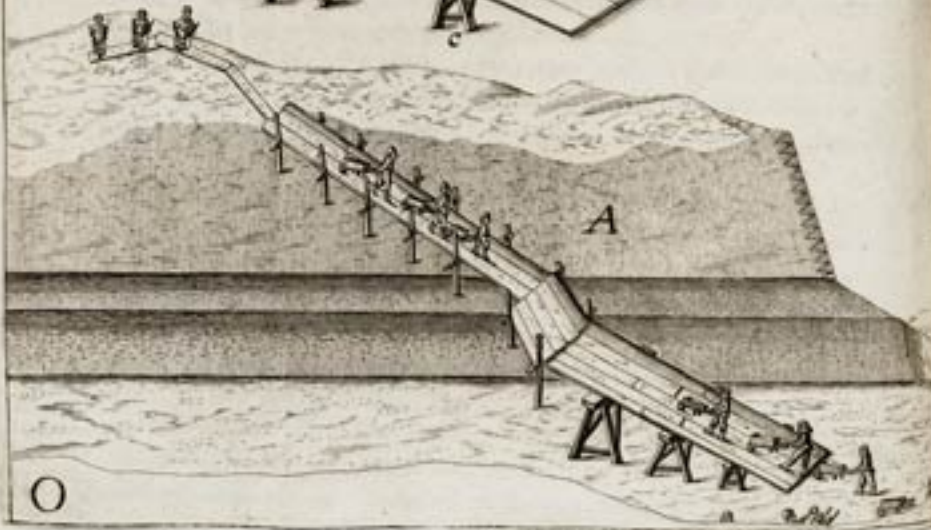
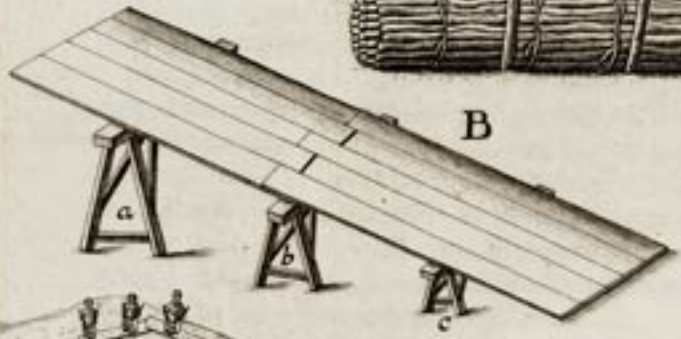
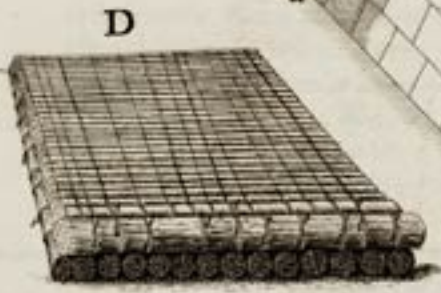
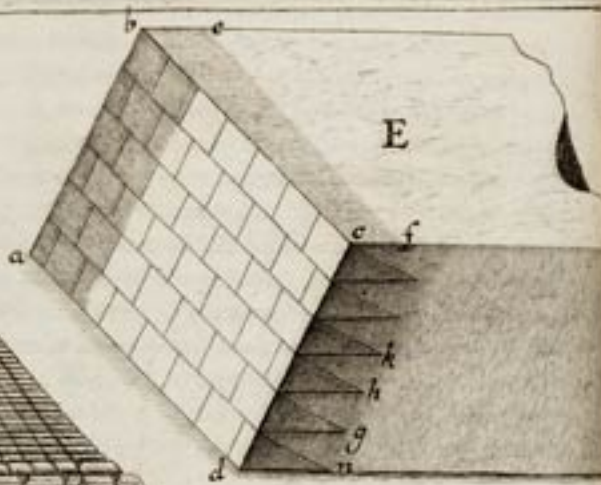
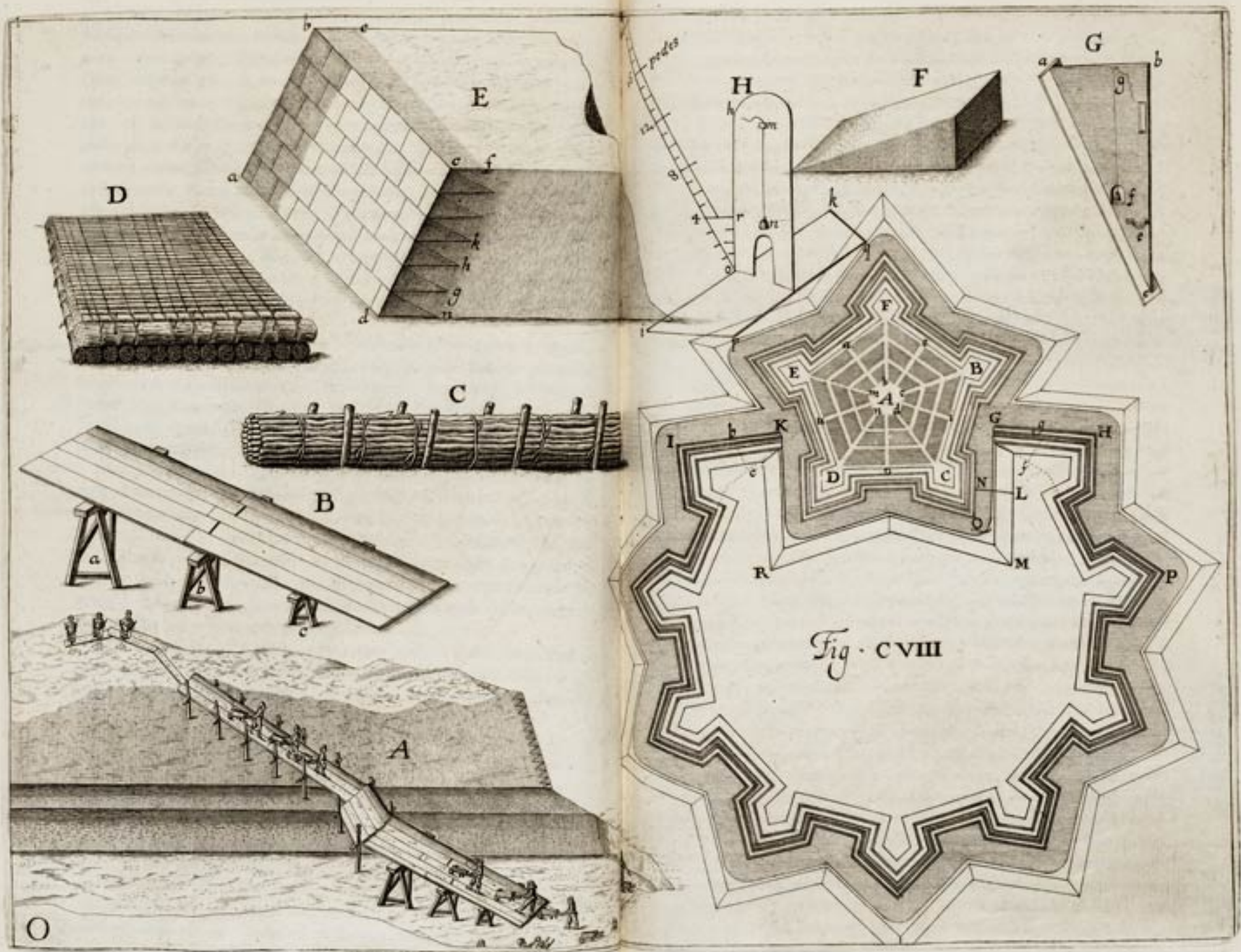

Fig. CVIII



# HAVRE DE GRACE.

*Marais.*

*Marais.*

*Terre ferme.*

*Citadelle.*

*Marais.*

*LA MER.*

*Virge. Verges. Toisen.*

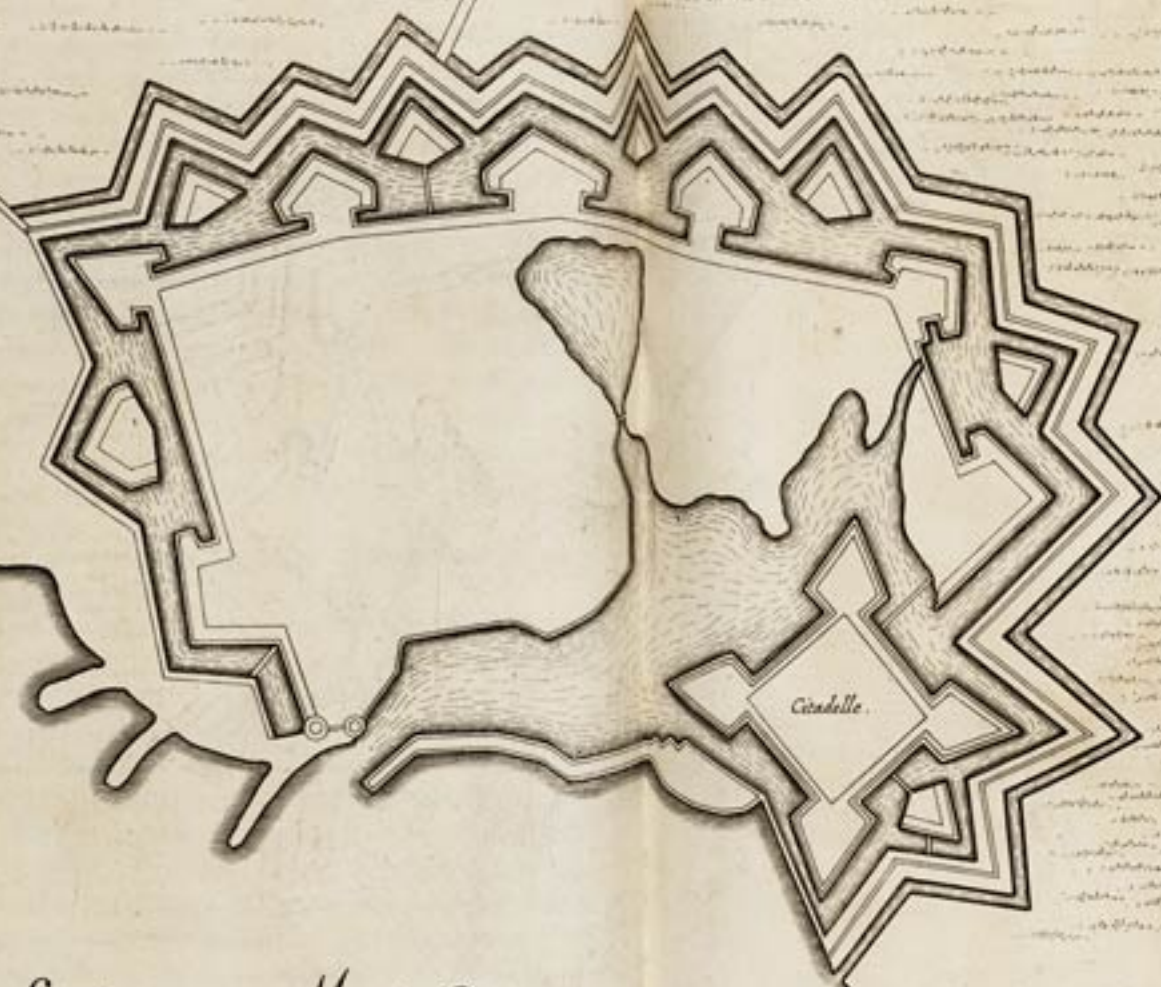



S. MALO.

S. A. M. E. R.



O C E A N U S.

Verge. Roeden.

ANTWERPEN.

Virga. Roeden.

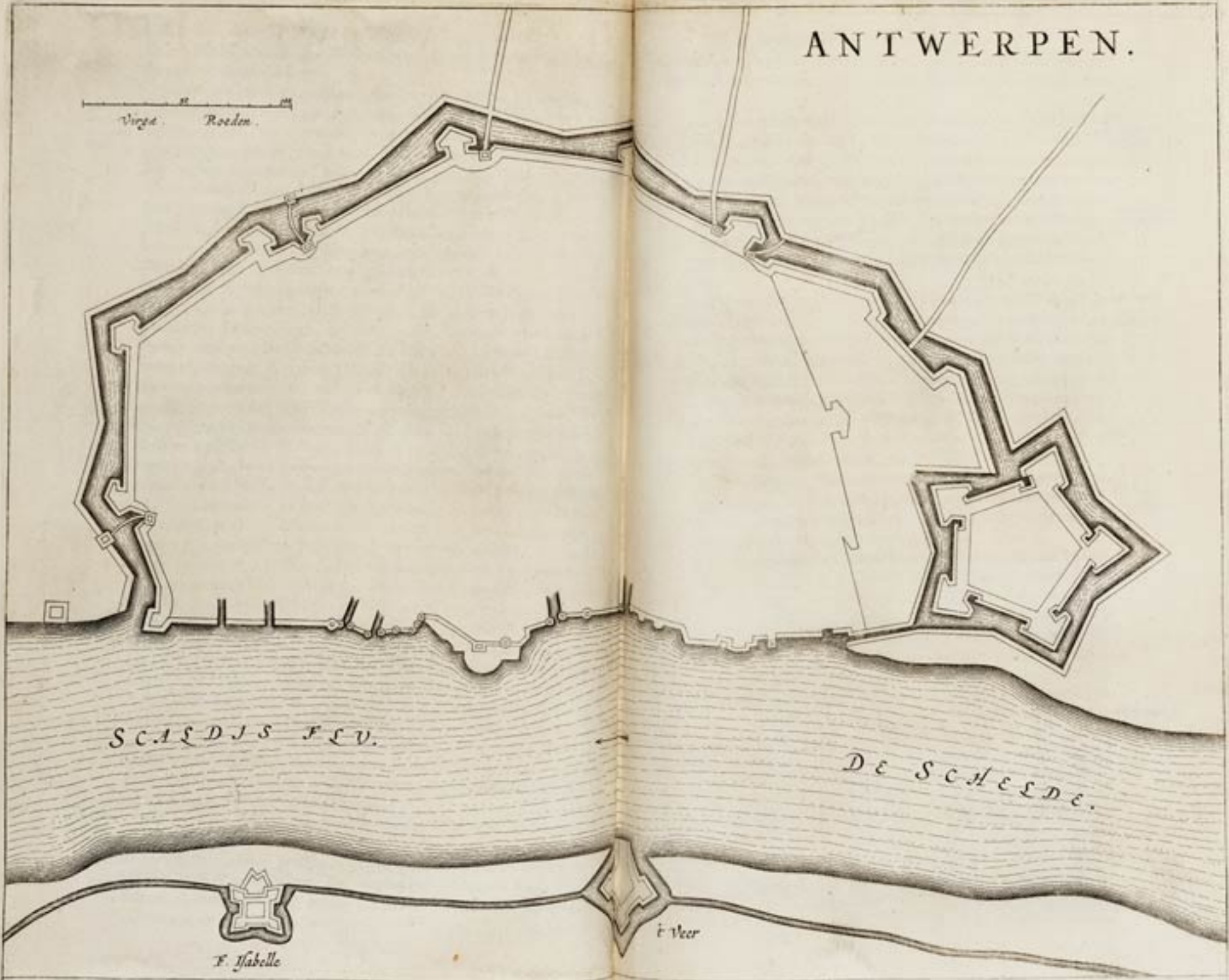

SCALEDJS FLEV.

DE SCHEDE.

F. Isabelle

t Veer



# HAMBURG.

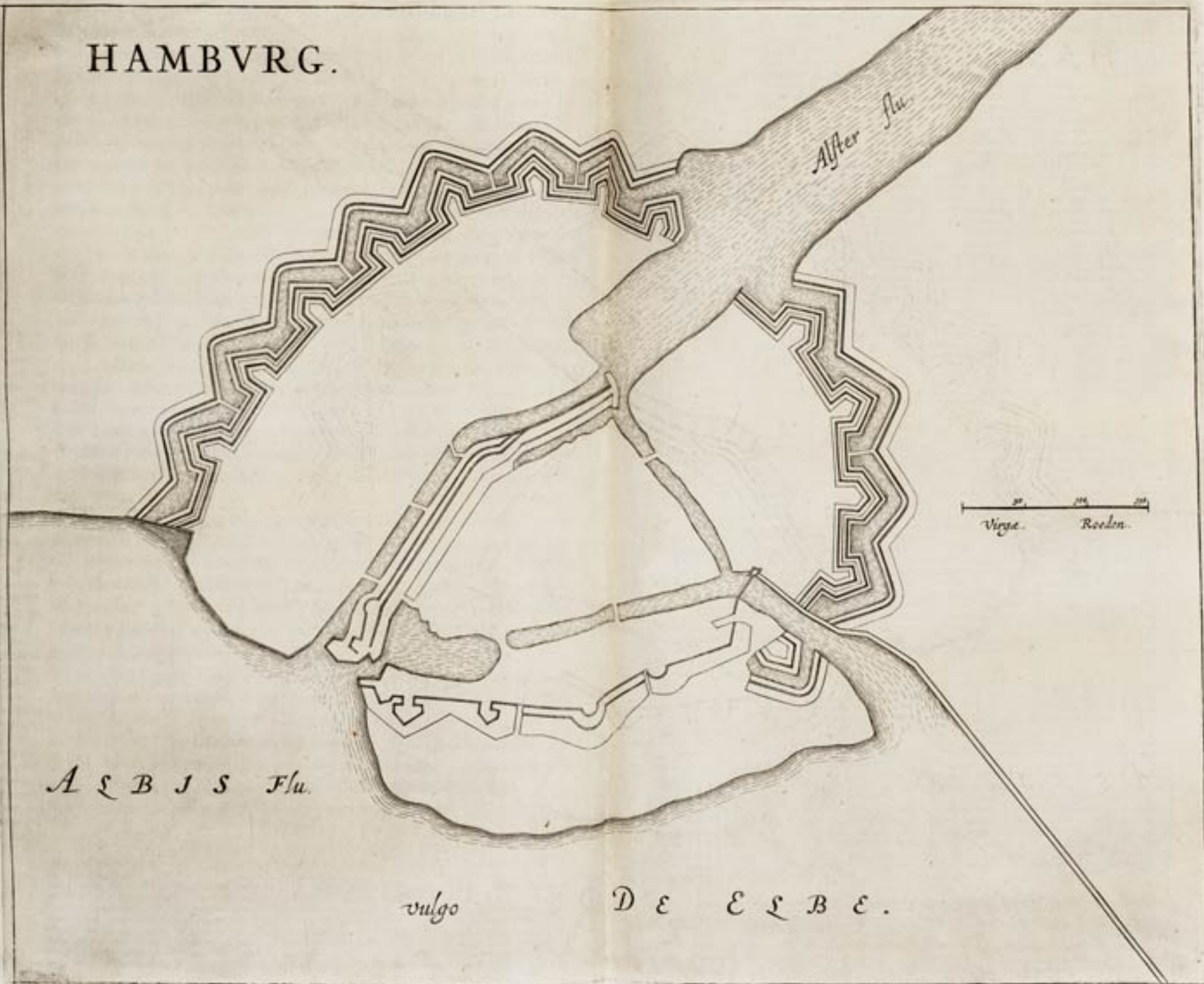

*Alster flu.*

Virga. Roeden.

*A. B. J. S. Flu.*

*vulgo DE E. B. E.*

GROENINGEN.

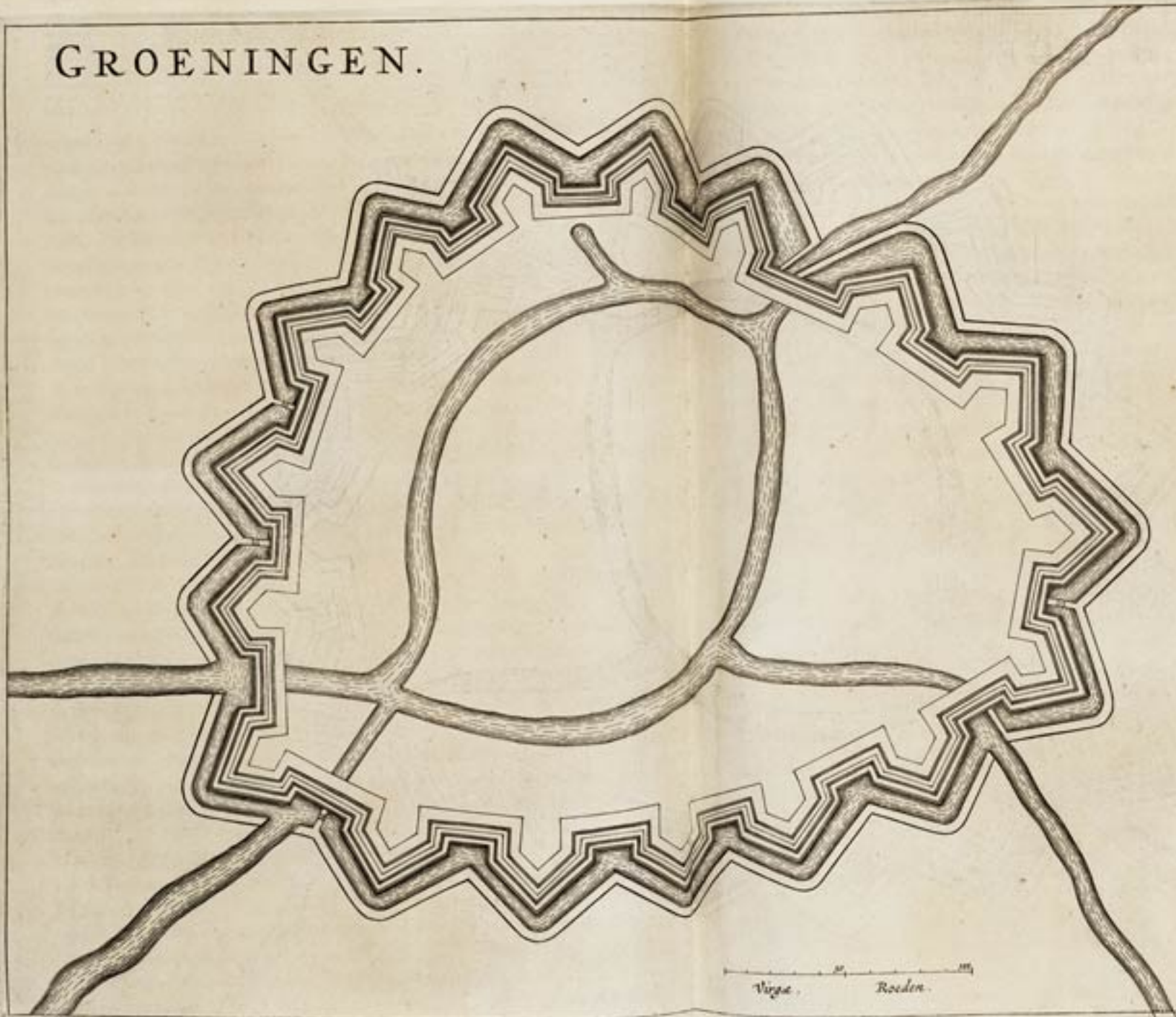
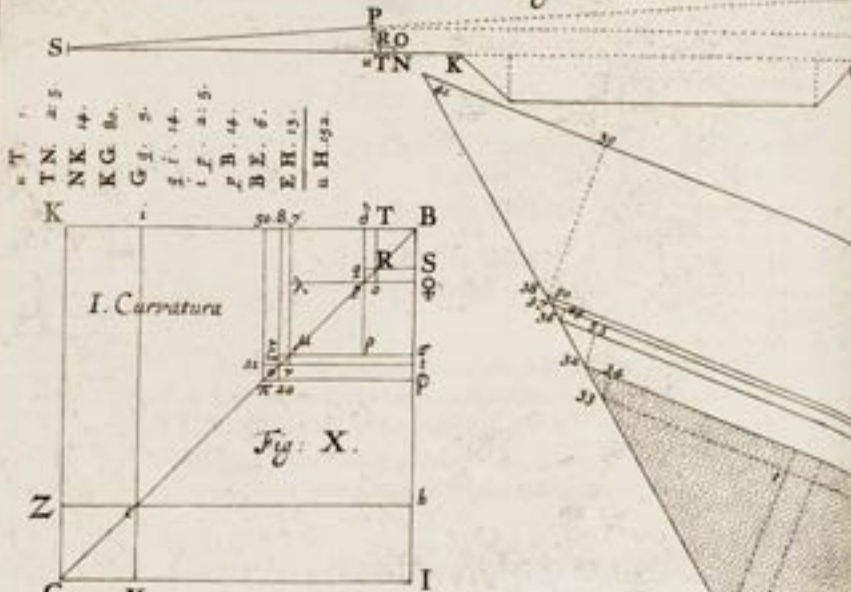



Fig: CXIV.



I. Curvatura

Fig: X.

Fig: CXVI.

Fig: CXVII.

2. Curvatura

Fig: CXI.

Fig: CXII.

Fig: CXII.

3. Curvatura.

Fig: CXIII.

Fig: CXV.

Fig: CXIX.

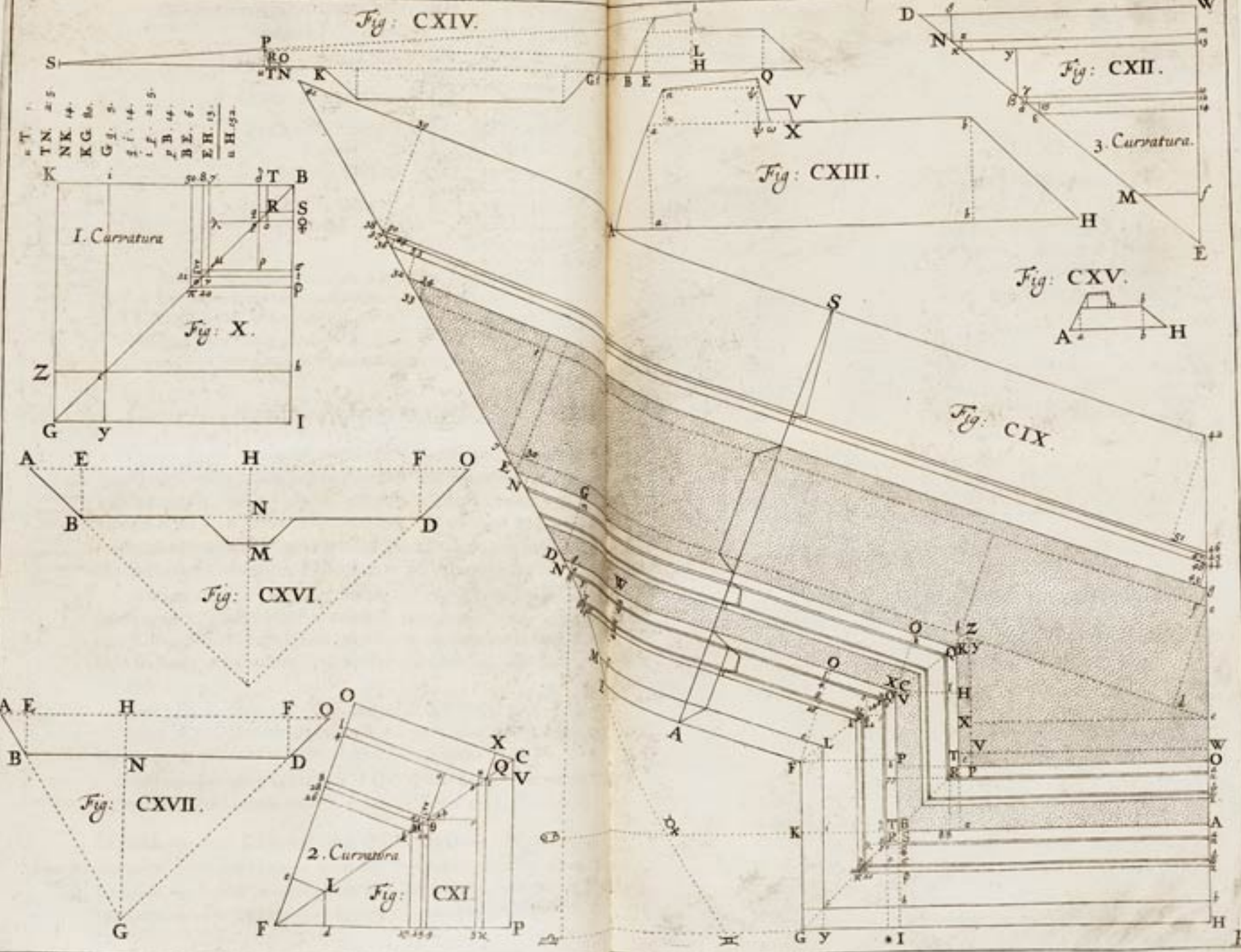



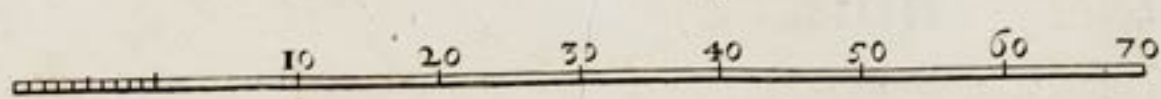
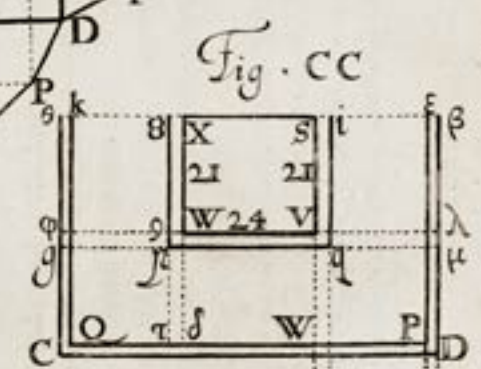
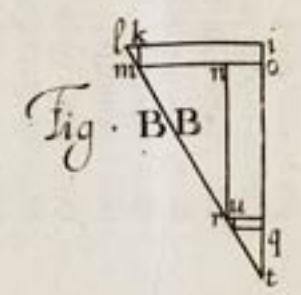
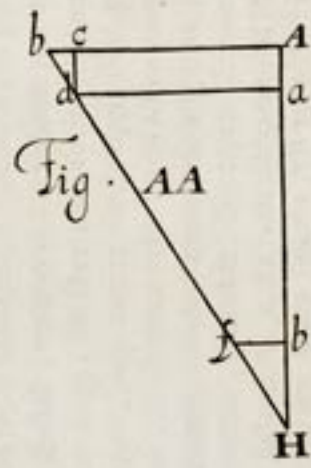
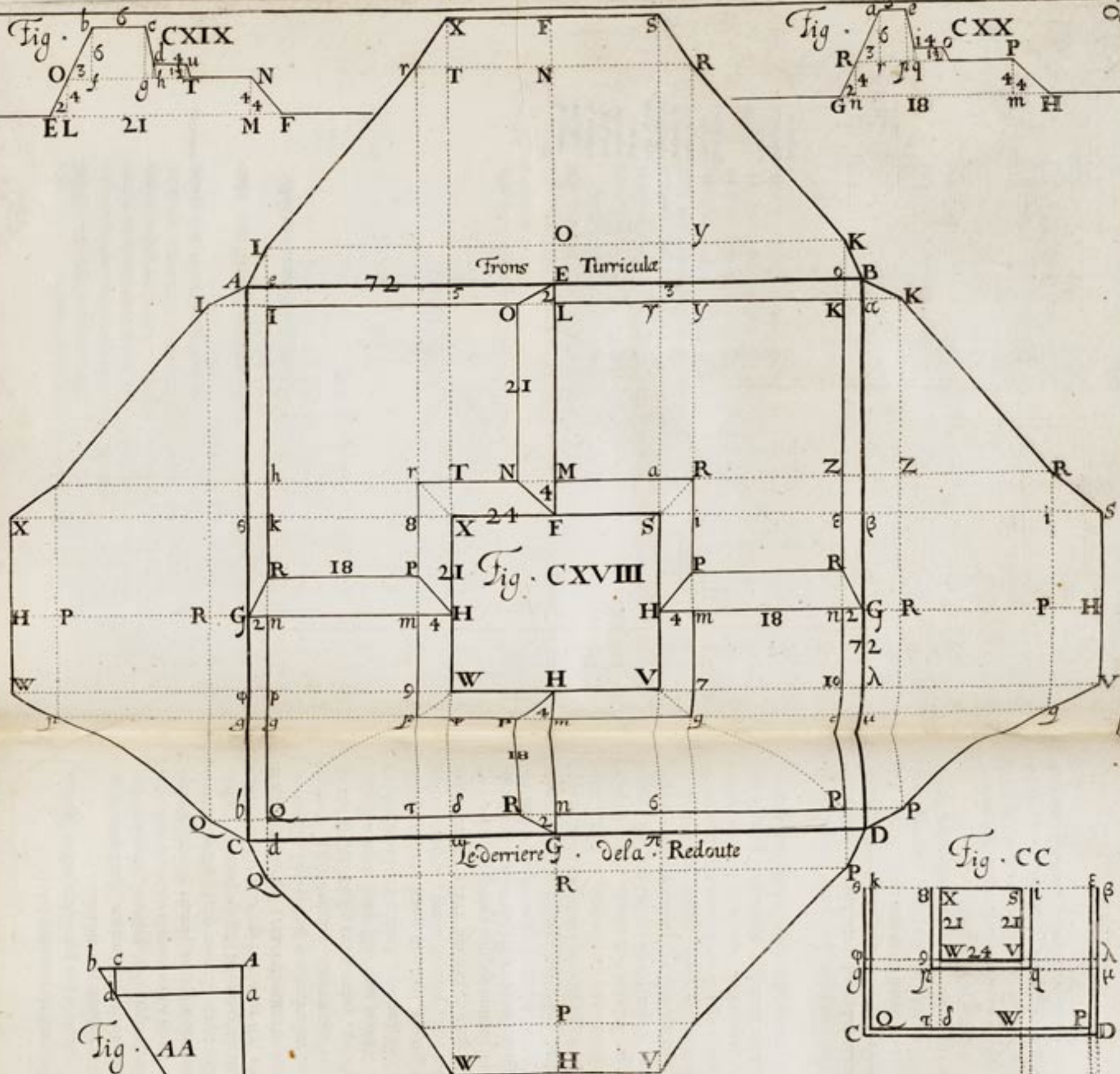
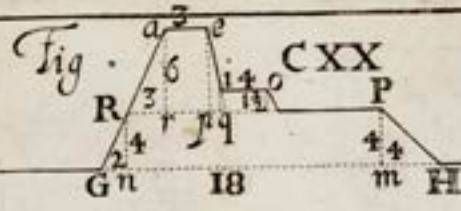



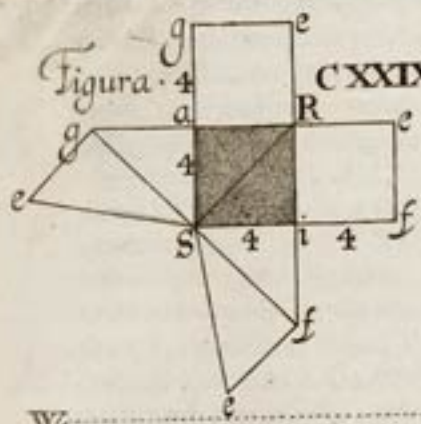

Fig. CXXVIII

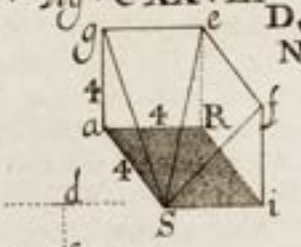

Fig. CXXX

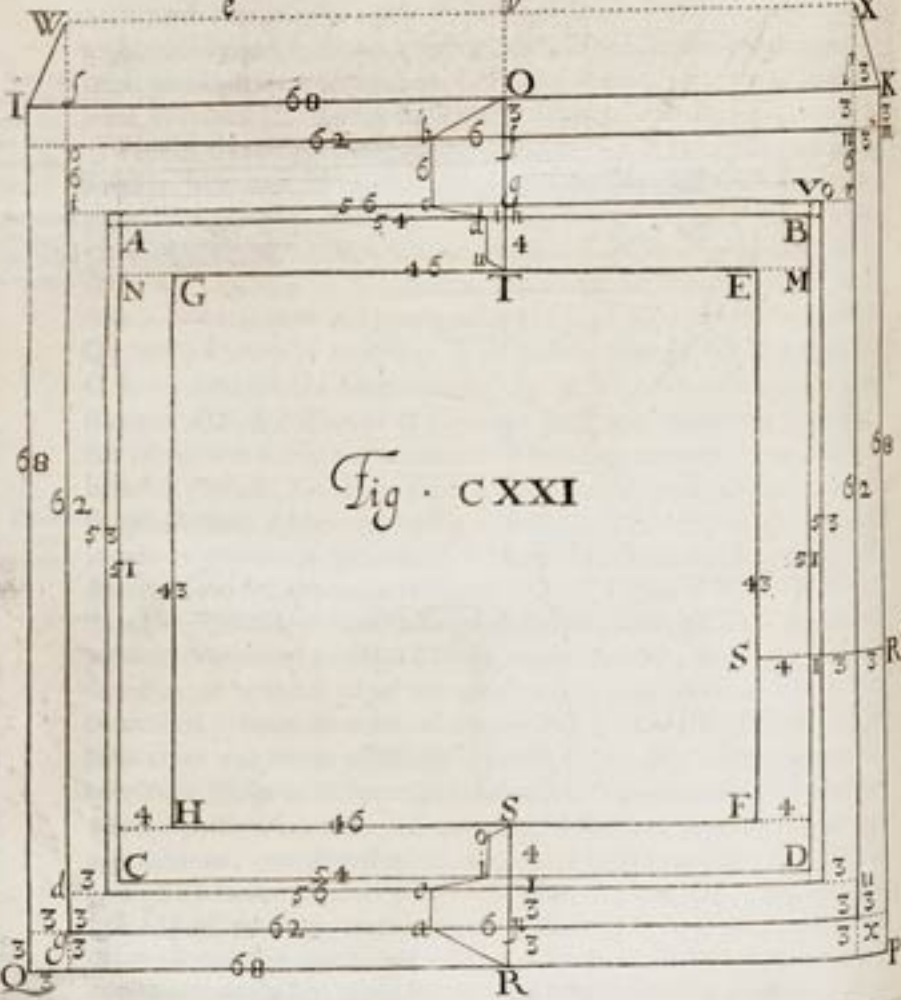
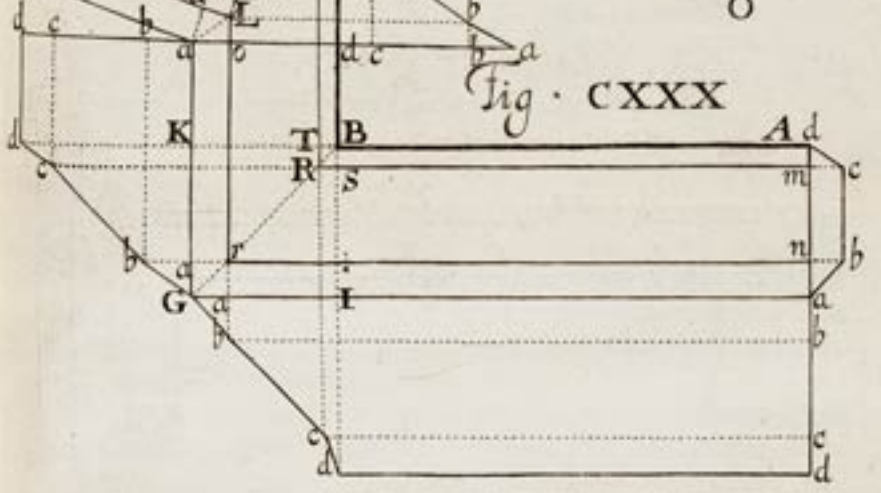

Fig. CXXI

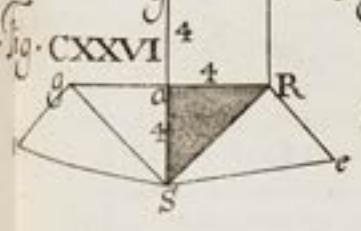

Fig. CXXVII

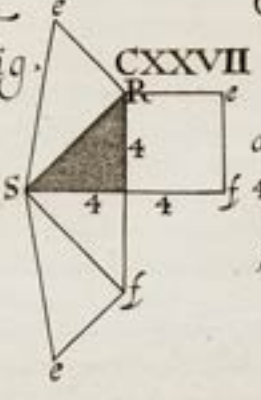
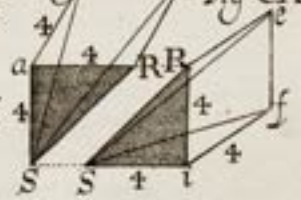

Fig. CXXIV





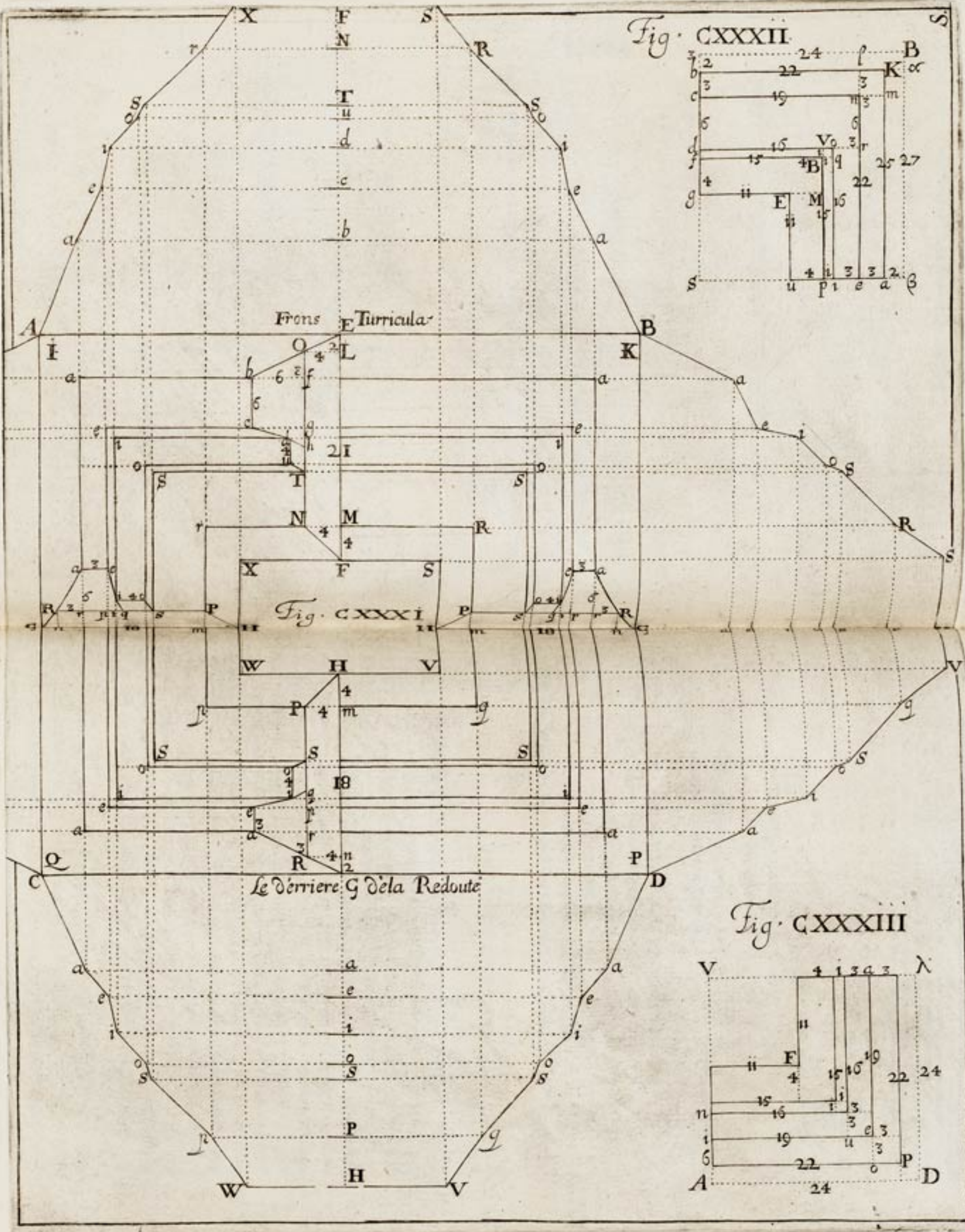

Fig. CXXXII

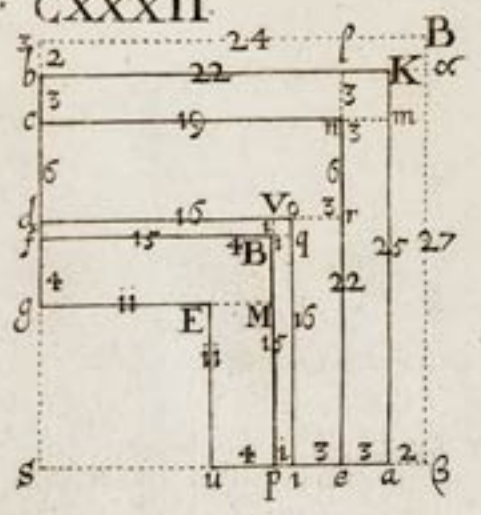
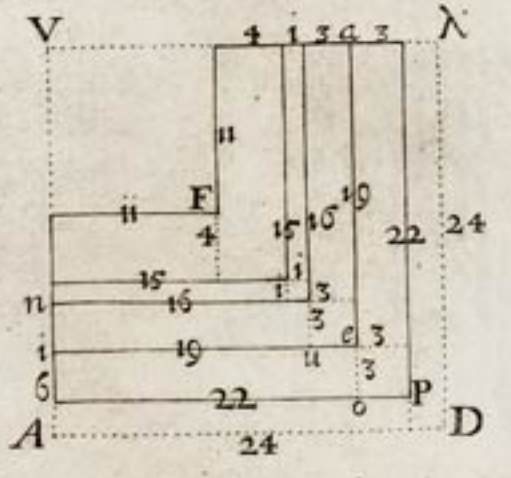

Fig. CXXXI

Fig. CXXXIII





GENEVE.

Lac de Geneve.

S<sup>t</sup>. Gervais

Rhone

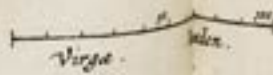

S<sup>t</sup>. GEERVYDENBERG.



50 100 150  
Virga. Roeden.



VLISSINGEN.

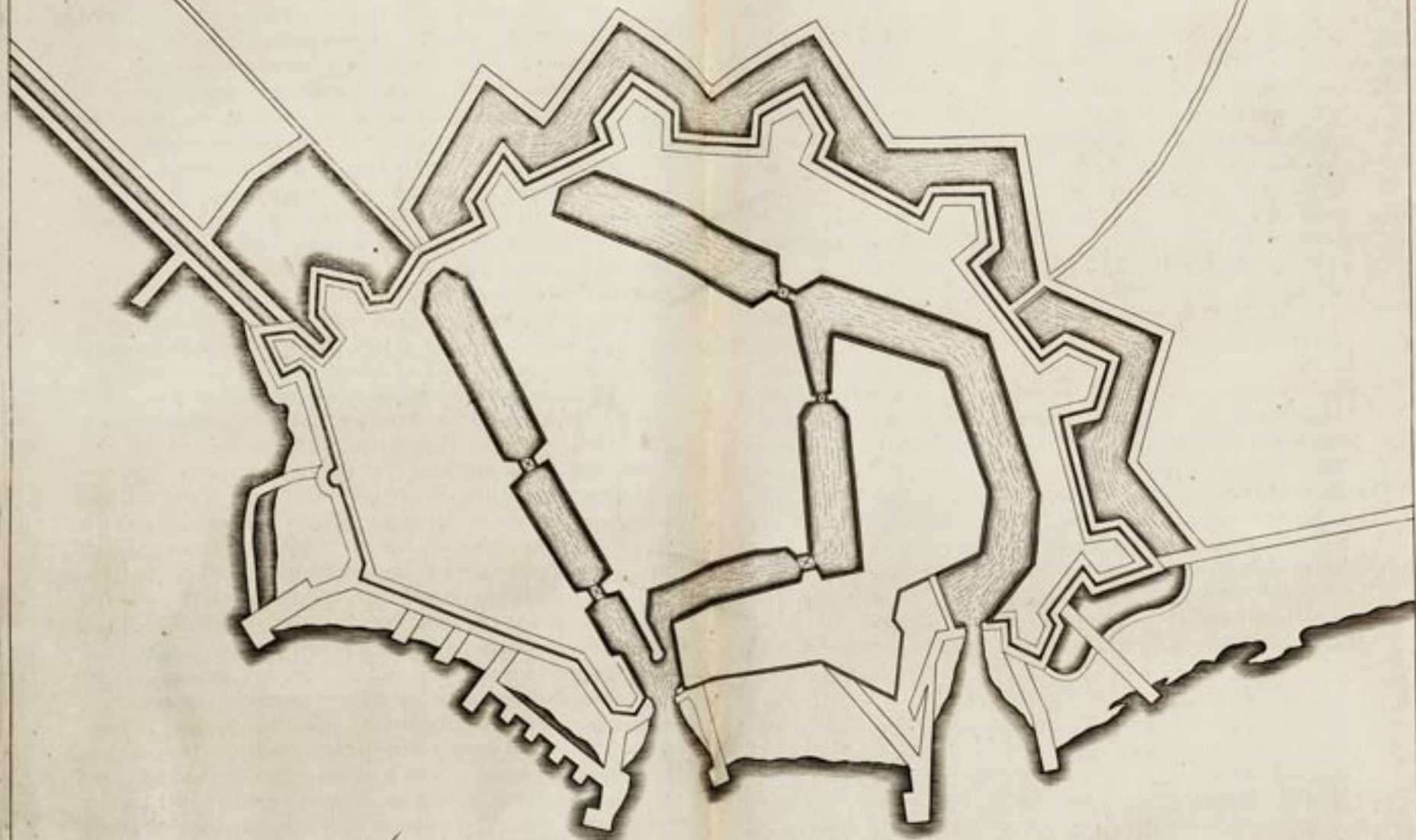

DE HOUT

Wijde Roeden.



SHERTOGENBOSCH.

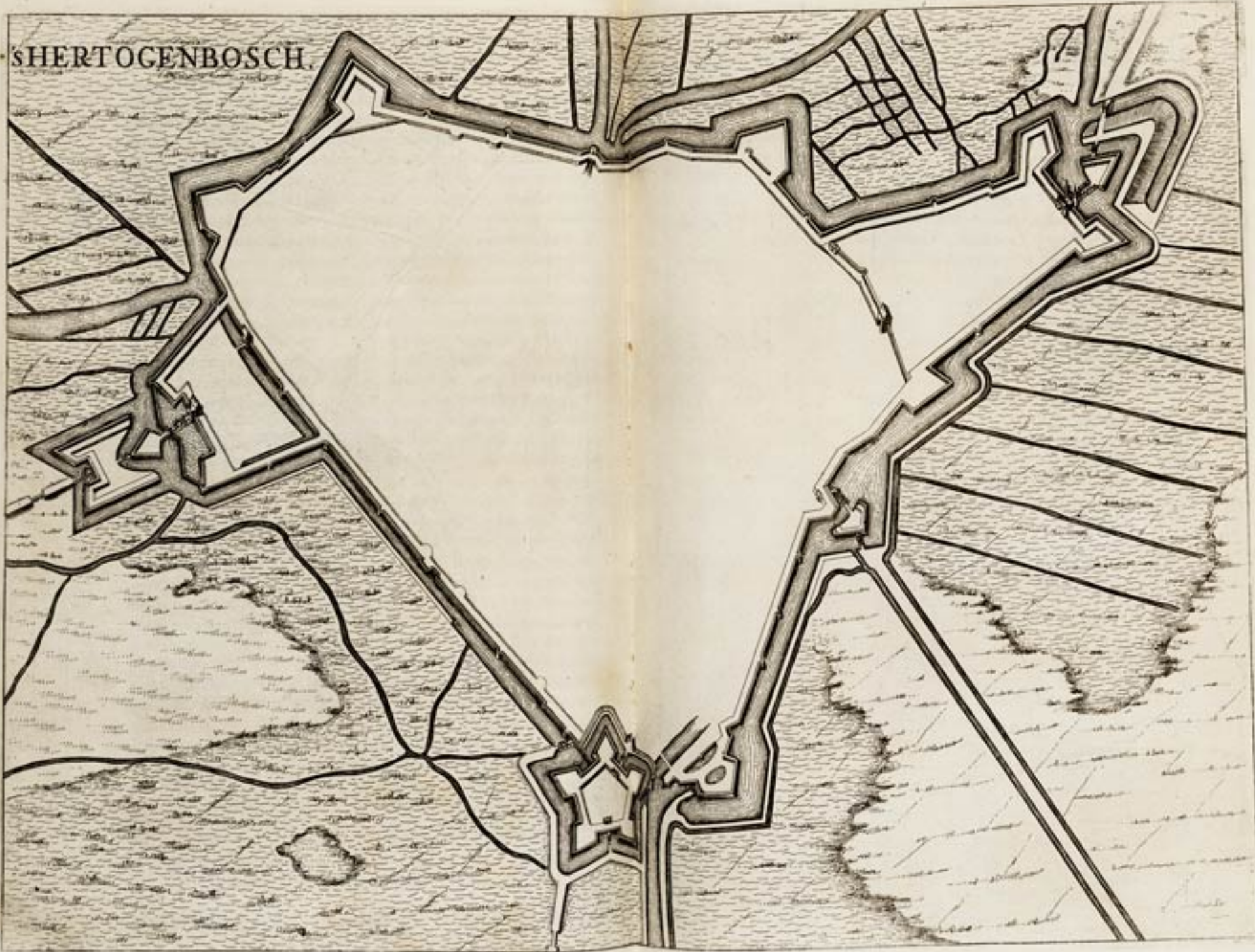



# WOLFFENBUTTEL.

*Moeras*

*Moeras*

*Moeras*

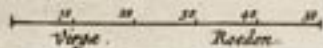



YSENDIJK.

$\frac{10}{10}$   $\frac{20}{20}$   $\frac{30}{30}$   $\frac{40}{40}$   $\frac{50}{50}$   
Virga Redon

DE HOEDT.

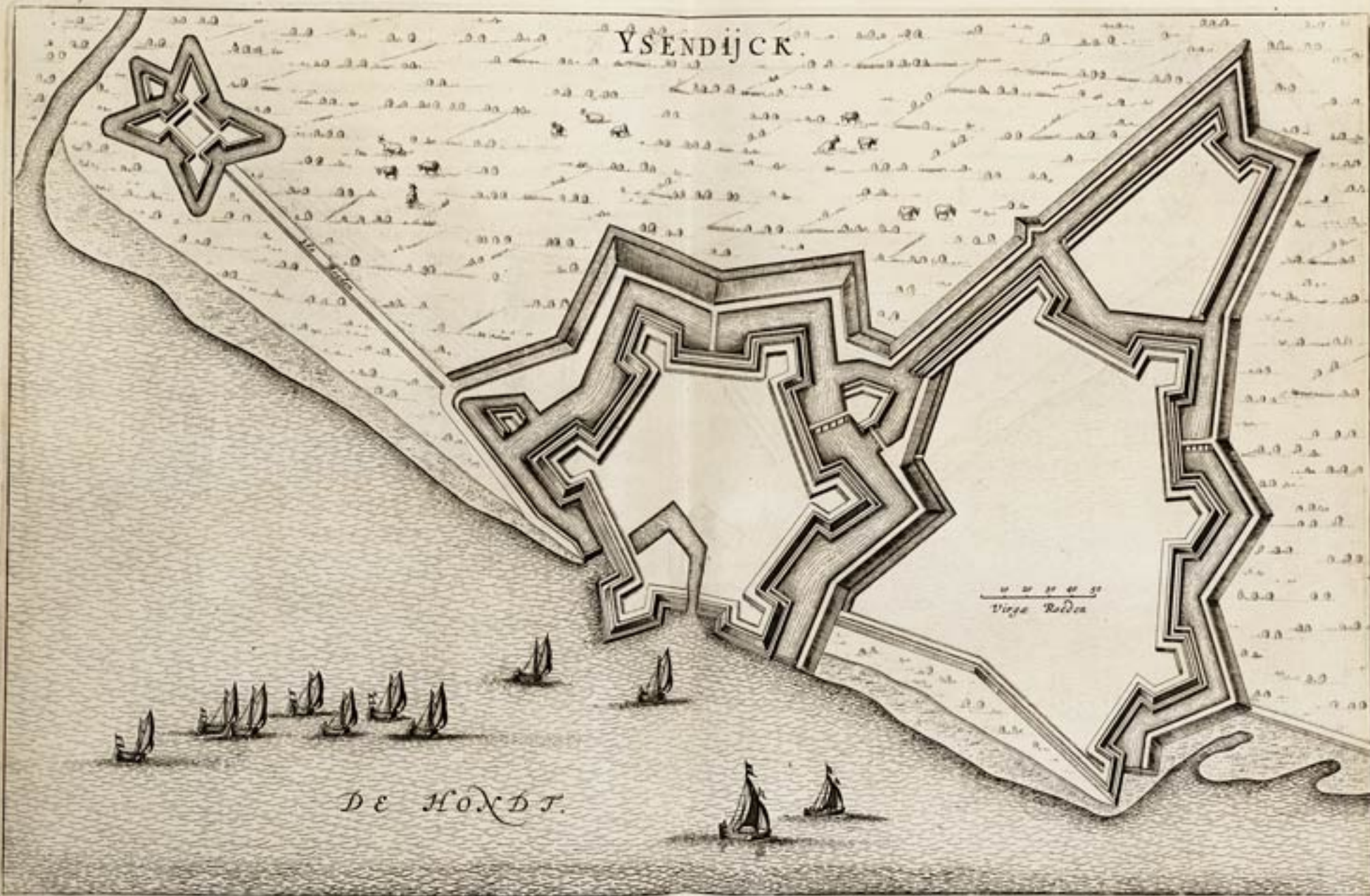





1. De oude polder
2. Cafemst
3. Nix nieuwe woftravelin
4. De weftpoort
5. Nieu porceffie
6. Helmont
7. De oude Sluys
8. Santbil
9. Nabe maen fo hoogh als de wal
10. Sluys eerst gemackct om water inde gracht te fetten
11. Trenchement
12. Bolwerck
13. Contrefcarp
14. Nabe maen
15. Een sluys eerst gemackct
16. Sortie nae de polder nabe maen
17. Een Sortie
18. Nieu polder
19. Sortie
20. Nieu helmet
21. Sortie
22. Nieu weftpoort
23. Vlammensburgh
24. Peckels bolwerck
25. Nieu Polder
26. Spaens bolwerck
27. Kofthul oft Suydoeffbolwerck
28. Suidbolwerck oft Treurenburgh
29. De Vrygaerden
30. Polder halvemaen
31. Bateria
32. Cotte
33. Hier legghen de fchepen
34. Nieu Santbil daer de oude kerck plach te ftan
35. Nieuwe haven
36. Noordoeffbolwerck
37. De oeff poort en het ravelin
38. Oefftravelin
39. Spaens halvemaen
40. Slimmers halvemaen
41. Elcks verdriet
42. Suydoefftravelin
43. Suytravelin

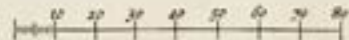

BERGIN OP ZOOM.

VOS MEER.



— 25 —  
Vijze. Rooden.



